

step 2

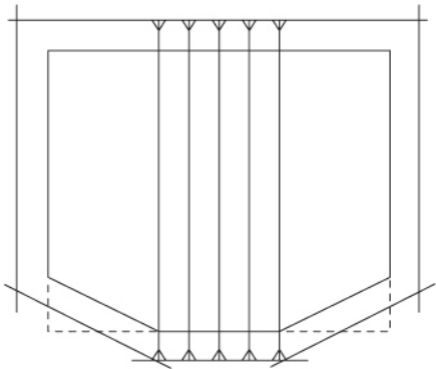

step 3