



Chapter 24
Practice Test 1

Reasoning Through Language Arts

Welcome!

Here is some information that you need to know before you start this test:

- You should not spend too much time on a question if you are not certain of the answer; answer it the best you can, and go on to the next question.
- If you are not certain of the answer to a question, you can mark your answer for review and come back to it later.
- This test has three sections.
- You have **35 minutes** to complete Section 1.
- When you finish Section 1, you may review those questions.
- You may not go back to Section 1 once you have finished your review.
- You have **45 minutes** to complete the Extended Response question in Section 2.
- After completing Section 2, you may take a 10-minute break.
- You have **60 minutes** to complete Section 3.
- When you finish Section 3, you may review those questions.

Turn the page to begin.

GO ON TO THE NEXT PAGE

Reasoning Through Language Arts, Section 1

Questions 1 through 8 refer to the following passage.

Excerpt from *A Popular Schoolgirl* by Angela Brazil

- 1 The Saxons were spending their summer holidays at a farm near the seaside, and for the first time in four long years the whole family was reunited. Mr. Saxon, Egbert, and Athelstane had only just been demobilized, and had hardly yet settled down to civilian life. They had joined the rest of the party at Lynstones before returning to their native town of Grovebury. The six weeks by the sea seemed a kind of oasis between the anxious period of the war that was past and gone, and the new epoch that stretched ahead in the future. To Ingred they were halcyon days. To have her father and brothers safely back, and for the family to be together in the midst of such beautiful scenery, was sufficient for utter enjoyment. She did not wish her mind to venture outside the charmed circle of the holidays. Beyond, when she thought about it all, lay a nebulous prospect, in the center of which school loomed large.
- 2 On this particular hot August afternoon, Ingred welcomed an excursion in the sidecar. She had not felt inclined to walk down the white path under the blazing sun to the glaring beach, but it was another matter to spin along the high road till, as the fairy tales put it, her hair whistled in the wind. Egbert was anxious to set off, so Hereward took his place on the luggage-carrier, and, after some back-firing, the three started forth. It was a glorious run over moorland country, with glimpses of the sea on the one hand, and craggy tors on the other, and round them billowy masses of heather, broken here and there by runnels of peat-stained water. If Egbert exceeded the speed-limit, he certainly had the excuse of a clear road before him; there were no hedges to hide advancing cars, neither was there any possibility of whisking round a corner to find a hay-cart blocking the way. In the course of an hour they had covered a considerable number of miles, and found themselves whirling down the tremendous hill that led to the seaside town of Chatcombe.
- 3 Arrived in the main street they left the motorcycle at a garage, and strolled on to the promenade, joining the crowd of holiday-makers who were sauntering along in the heat, or sitting on the benches watching the children digging in the sand below. Much to Ingred's astonishment she was suddenly hailed by her name, and, turning, found herself greeted with enthusiasm by a schoolfellow.
- 4 "Ingred! What a surprise!"
- 5 "Avis! Who'd have thought of seeing you?"
- 6 "Are you staying here?"

GO ON TO THE NEXT PAGE

Reasoning Through Language Arts, Section 1

- 7 "No, only over for the afternoon."
- 8 "We've rooms at Beach View over there. Come along and have some tea with us, and your brothers too. Yes, indeed you must! Mother will be delighted to see you all. I shan't let you say no!"
- 9 Borne away by her hospitable friend, Ingrid presently found herself sitting on a seat in the front garden of a tall boarding-house facing the sea, and while Egbert and Hereward discussed motor-cycling with Avis's father, the two girls enjoyed a confidential chat together.
- 10 "Only a few days now," sighed Avis, "then we've got to leave all this and go home. How long are you staying at Lynstones, Ingrid?"
- 11 "A fortnight more, but don't talk of going home. I want the holidays to last forever!"
- 12 "So do I, but they won't. School begins on the twenty-first of September. It will be rather sport to go to the new buildings at last, won't it? By the by, now the war's over, and we've all got our own again, I suppose you're going back to Rotherwood, aren't you?"
- 13 "I suppose so, when it's ready."
- 14 "But surely the Red Cross cleared out ages ago, and the whole place has been done up? I saw the paperhangers there in June."
- 15 "Oh, yes!" Ingrid's voice was a little strained.
- 16 "You'll be so glad to be living there again," continued Avis. "I always envied you that lovely house. You must have hated lending it as a hospital. I expect when you're back you'll be giving all sorts of delightful parties, won't you? At least that's what the girls at school were saying."
- 17 "It's rather early to make plans," temporized Ingrid.
- 18 "Oh, of course! But Jess and Francie said you'd a gorgeous floor for dancing. I do think a fancy-dress dance is about the best fun on earth. The next time I get an invitation, I'm going as a Quaker maiden, in a gray dress and the duckiest little white cap. Don't you think it would suit me? With your dark hair you ought to be something Eastern. I can just imagine you acting hostess in a shimmery sort of white-and-gold costume. *Do* promise to wear white-and-gold!"

GO ON TO THE NEXT PAGE

Reasoning Through Language Arts, Section 1

19 “All right,” laughed Ingrid.

20 “It’s so delightful that the war’s over, and we can begin to have parties again, like we used to do. Beatrice Jackson told me she should never forget that Carnival dance she went to at Rotherwood five years ago, and all the lanterns and fairy lamps. Some of the other girls talk about it yet. Hullo, that’s the gong! Come indoors, and we’ll have tea.”

1. Which quotation from the story supports the idea that Ingrid’s relatives have had military experience?

- A. “Mr. Saxon, Egbert, and Athelstane had only just been demobilized, and had hardly yet settled down to civilian life.”
- B. “The six weeks by the sea seemed a kind of oasis between the anxious period of the war that was past and gone, and the new epoch that stretched ahead in the future.”
- C. “By the by, now the war’s over, and we’ve all got our own again, I suppose you’re going back to Rotherwood, aren’t you?”
- D. “To have her father and brothers safely back, and for the family to be together in the midst of such beautiful scenery, was sufficient for utter enjoyment.”

2. Which definition best matches the use of the word “native” in paragraph 1?

- A. natural
- B. wild
- C. original
- D. inherited

3. Read the following sentence from paragraph 2.

It was a glorious run over moorland country, with glimpses of the sea on the one hand, and craggy tors on the other, and round them billowy masses of heather, broken here and there by runnels of peat-stained water.

The detailed description of the landscape enhances the story by

- A. revealing the dangerous nature of the motorcycle trip.
- B. further emphasizing Ingrid’s feelings about her summer home.
- C. showing the contrast between the sea and the cliffs.
- D. introducing Egbert as a secondary character.

GO ON TO THE NEXT PAGE

Reasoning Through Language Arts, Section 1

4. Read the sentences from paragraph 14.

“But surely the Red Cross cleared out ages ago, and the whole place has been done up? I saw the paperhangers there in June.”

What is the significance to Ingred of the “place” mentioned in the passage?

- A. It is Ingred’s family home which had been occupied by wartime personnel.
 - B. It is the town where Ingred lives, which has a Red Cross military hospital.
 - C. It is a popular ballroom that has been undergoing renovations in preparation for a dance.
 - D. It is one of the new buildings at Ingred’s school, where she dreads returning.
5. In paragraph 15, which characteristic does the passage reveal about Ingred as she responds to Avis?
- A. reluctance
 - B. agreement
 - C. exhaustion
 - D. enthusiasm

6. Drag and drop the events into the chart to show the order in which they occur in the excerpt. (For this practice test, write the event letters in the chart.)

Order of Events



(a) Egbert drives Ingred to the beach.

(b) Ingred is invited to tea.

(c) Avis talks about a fancy-dress dance.

(d) The Saxons unite at Lynstones.

GO ON TO THE NEXT PAGE

Reasoning Through Language Arts, Section 1

7. Drag and drop each word that describes Ingrid into the character web. (For this practice test, write each word in the web.)

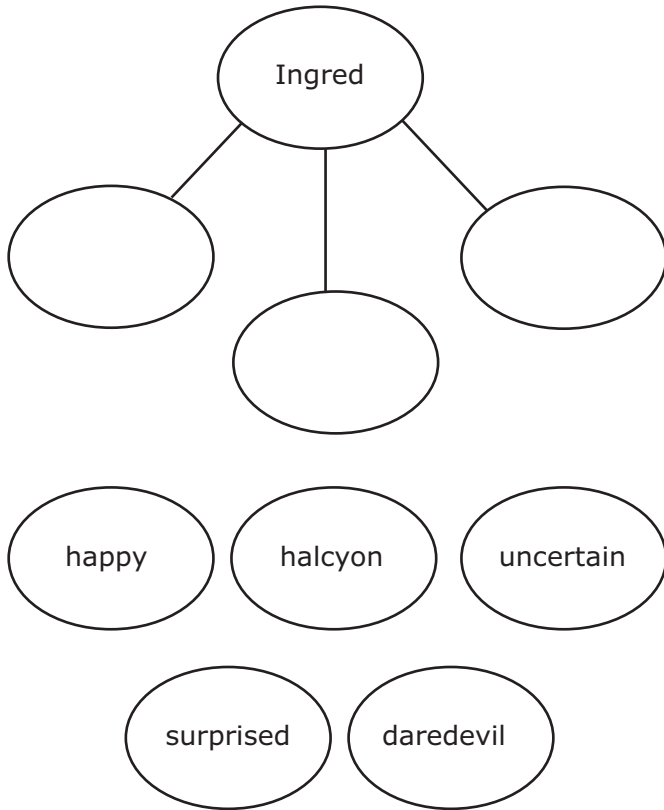

8. Based on the details in the story, what can readers predict about Avis?
- A. She will be going to school with Ingrid for the first time in September.
 - B. She will plan and host a dance after school starts.
 - C. She will travel to Lynstones when the afternoon is over.
 - D. She will return to her hometown before Ingrid does.

GO ON TO THE NEXT PAGE

Reasoning Through Language Arts, Section 1

Questions 9 through 16 refer to the following article.

Devices and Additives to Improve Fuel Economy and Reduce Pollution—Do They Really Work?

By the U.S. Environmental Protection Agency

Watch Out!

- 1 Have you seen advertisements for products that “Double Your Fuel Economy,” or “Clean-up Your Car’s Tailpipe Exhaust”? Be careful about these products; don’t be fooled by erroneous claims.

Fuel Additives

- 2 Some advertisements claim that certain fuel additives have been approved by the EPA. While the EPA requires fuel additives to be “registered,” the EPA does not test additives for engine efficiency, emissions benefits, or safety as part of the registration. To register an additive, manufacturers report the chemical composition and technical, marketing, and health effects information. The EPA does NOT endorse or certify fuel additives; registration with the EPA does not imply anything about the claims made by the manufacturer.

Aftermarket Devices to Improve Fuel Economy or Reduce Emissions

- 3 If a device has significant benefits, the manufacturer may apply for EPA testing through the Voluntary Aftermarket Retrofit Device Evaluation Program. Very few manufacturers have applied for this program in the past 10 years. Most devices tested in earlier years had a neutral or negative effect on fuel economy and/or exhaust emissions. Without this report, the EPA has no information about the safety of the device or its impact on fuel efficiency or the environment.

Popular Devices and Their Effects

- Devices that turn water into fuel: The EPA has received no credible and complete data showing fuel economy benefits from devices that split water molecules into hydrogen and oxygen gas, which is then burned with your fuel. Some devices’ installation instructions include adjustments that the EPA would consider tampering. Tampering with your car’s emissions control system is punishable by significant fines.
- Fuel line devices: Some devices heat, magnetize, ionize, irradiate, or add metals to the fuel lines. EPA testing of such devices has shown no substantive effect on fuel economy or exhaust

GO ON TO THE NEXT PAGE

Reasoning Through Language Arts, Section 1

emissions. Installation of devices that retard timing or adjust the air-fuel ratio of the vehicle may be considered tampering.

- Mixture enhancers: The EPA has received no credible and complete data showing fuel economy benefits from devices that claim to increase fuel efficiency by creating aerodynamic properties or turbulence that improves the air-fuel mix prior to combustion.

Aftermarket Alternative Fuel Conversions

- 4 Aftermarket alternative fuel conversions are sometimes alleged to improve fuel economy and reduce pollution. However, it is difficult to re-engineer a vehicle to operate properly on a different fuel, and especially difficult to ensure that the vehicle will meet emission standards. So, before choosing a vehicle conversion, consider these factors:
- It is not the fuel alone but the integration of engine, fueling, exhaust and evaporative emission control system designs that determines how clean a vehicle will be. Vehicle conversion systems must retain a similarly integrated design and functionality to retain low emissions.
 - Gaseous and alcohol fuels are less energy dense than conventional fuels, so your fuel efficiency per gallon of fuel will decrease compared to gasoline or diesel.
 - Be sure to check whether your vehicle's manufacturer will honor the warranty after conversion.

If the conversion manufacturer has not followed EPA guidelines, you may be violating the tampering prohibition and/or increasing the release of harmful exhaust and evaporative emissions.

- 5 Therefore, thoroughly research any aftermarket part or additive before purchasing, and remember the old adage, "If it sounds too good to be true, it probably is."

Improve Your Fuel Economy

By the U.S. Department of Energy

Fuel-Saving Habits

- 6 There are several things you can do to obtain the best possible fuel economy and produce the lowest possible emissions.
- Avoid idling. Idling gets 0 miles per gallon and costs as much as \$0.04 per minute.

GO ON TO THE NEXT PAGE

Reasoning Through Language Arts, Section 1

- Keep tires inflated to the recommended pressure, and use the recommended grade of motor oil, which can improve fuel economy by up to 5%.
- Drive more efficiently. Each 5 MPH you drive over 60 MPH can reduce your fuel economy by 7%.

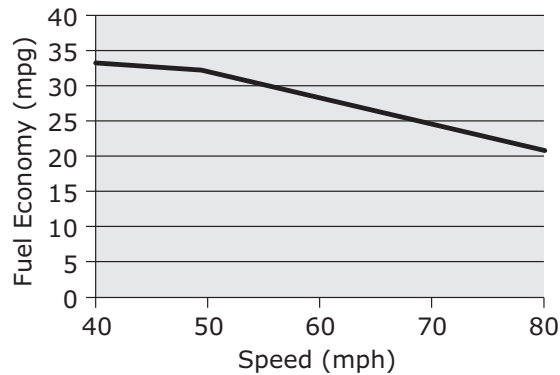

- Keep your car in shape. Fixing a car that is out of tune can improve your gas mileage by about 4%.
- Combine your trips. Many short trips taken from a cold start can use twice as much fuel as one multipurpose trip.
- Avoid carrying unneeded items. An extra 100 pounds can decrease fuel economy by 1%–2%.

Fuel-Saving Technology Highlight: Start-Stop Systems

- 7 An energy-saving feature is now available that can help you save fuel in stop-and-go traffic, at red lights, and in other situations where your car would normally waste fuel idling. Start-stop systems turn off the engine when a vehicle comes to a stop and automatically start it back up when the brake is released or when the accelerator or clutch is pressed. It usually takes half a second or less to restart. Until recently, these systems were mostly found on hybrid vehicles, but as of the 2014 model year, they are available on about one hundred conventional vehicle models. By turning off the engine when it's not needed, start-stop systems can improve fuel economy by around 4 to 5 percent on average. Unlike a hybrid system, which can add thousands of dollars to a vehicle's cost, a start-stop system typically adds only a few hundred dollars. A start-stop system doesn't require you to drive differently, but it may take some time for you to get used to the way the vehicle operates or feels. Most systems are robust and easy to use. If you spend significant drive time idling, a vehicle equipped with a start-stop system might just be right for you!

Sources: Adapted and abridged from *Devices and Additives to Improve Fuel Economy and Reduce Pollution—Do They Really Work?*, U.S. Environmental Protection Agency, 2012, and *Model Year 2014 Fuel Economy Guide*, U.S. Department of Energy, 2016.

GO ON TO THE NEXT PAGE

Reasoning Through Language Arts, Section 1

9. Drag and drop two statements that express the EPA's purposes for writing its article into the empty boxes. (For this practice test, write the statement letters in the boxes below.)

EPA's Purposes

(a) To promote start-stop systems as a method to increase fuel economy

(b) To list the many harmful effects that emissions can have on the environment

(c) To caution consumers about deceptive advertising

(d) To give information about the role of the EPA in evaluating fuel additives and devices

(e) To list ways to increase fuel economy

10. Which conclusion is best supported by the Department of Energy article?
- A. Because of the advent of start-stop systems, other methods to improve fuel economy and reduce pollution are no longer necessary.
 - B. Start-stop systems offer better fuel economy benefits than aftermarket alternative fuel conversions.
 - C. Consumers seeking to save on fuel costs should adopt better driving habits.
 - D. Consumers should research any devices marketed to improve fuel economy, to make sure they have been tested and endorsed by the EPA.

11. What was the author's purpose for including the sentence "Very few manufacturers have applied for this program in the past 10 years" (paragraph 3) in the Environmental Protection Agency article?
- A. to emphasize that the EPA program is competitive and takes a long time to complete
 - B. to suggest that the claims made by many manufacturers cannot be verified
 - C. to show that only a few devices are effective enough to pass EPA testing
 - D. to urge more manufacturers to apply for the program, so that consumers will have better choices in the future
12. How does the chart extend the information in the article by the Department of Energy?
- A. by showing that fuel economy improves 5% with every 5 MPH a driver slows down
 - B. by showing that reducing driving speed is more effective than vehicle maintenance
 - C. by illustrating the effects of safer driving
 - D. by highlighting the optimum speed for every driving condition
13. How are the two articles similar?
- A. Both articles list methods to help reduce emissions.
 - B. Both articles mention devices that are reported to increase fuel economy.
 - C. Both articles use statistics to support their assertions about fuel economy.
 - D. Both articles describe a way to verify the claims made about a marketed device.

GO ON TO THE NEXT PAGE

Reasoning Through Language Arts, Section 1

14. Which idea about the effect of aftermarket fuel economy devices is included in the article by the EPA?
- A. Installation of the devices might be more costly than expected.
 - B. The devices can improve economy 4 to 5 percent.
 - C. The devices can be tested and registered by the EPA.
 - D. There is no information about the safety of these devices.
15. How does the “Fuel-Saving Habits” section (paragraph 6) of the Department of Energy article relate to the “Fuel-Saving Technology Highlight” section (paragraph 7)?
- A. The “Fuel-Saving Habits” section lists changes drivers can make to save fuel, while the “Fuel-Saving Technology Highlight” contradicts this list by claiming there is no need to drive differently.
 - B. The “Fuel-Saving Habits” list begins by cautioning against a bad driving habit; the “Fuel-Saving Technology Highlight” builds on this advice by recommending a device that automatically reduces this habit.
 - C. The “Fuel-Saving Habits” section implies that there are several ways to reduce fuel consumption, while the “Fuel-Saving Technology Highlight” implies that one of these ways is more effective than the others.
 - D. The “Fuel-Saving Habits” section focuses only on ways to operate a vehicle while the “Fuel-Saving Technology Highlight” focuses on devices that can be installed in vehicles.
16. In the Department of Energy article, what is the effect of the use of the word “robust” in paragraph 7?
- A. It reassures the reader that the start-stop system is sturdy and well-made.
 - B. It informs the reader that the start-stop system will not be hard to drive.
 - C. It cautions the reader that the start-stop system is fairly bulky and may increase the weight of the car.
 - D. It advises the reader that the start-stop system is not expensive.

GO ON TO THE NEXT PAGE

Reasoning Through Language Arts, Section 1

17. The passage below is incomplete. For each “Select” option, choose the option that correctly completes the sentence. (For this practice test, circle your selection.)

Macy Redizas
5366 Ardenhall Lane
Laughing Pines, NJ

Dear Ms Redizas:

As a fellow member of the Laughing Pines community, I am sending this to you with great concern for our quality of life. Surely you enjoy living in such a quiet and peaceful

Select...	▼
neighborhood, just as I do.	
neighborhood. Just as I do.	
neighborhood just as I do too.	
neighborhood; you just as much as I do.	

As it happens, in order to ensure a “quiet and peaceful” community, one sometimes must take precautions.

Select...	▼
The alarmingly increased burglary incidents, via news reports and social media posts, you must be aware of by now,	
By now, via news reports and social media posts, you must be aware of the alarming increase in burglary incidents	
Via news reports and social media posts you must be aware of by now, the alarming increase in burglary incidents	
The alarming increase in burglary incidents you must be aware of by now, via news reports and social media posts	

in our neighborhood during the past few years. While police may assert that this is an expected result of the continuing economic slump, that is no consolation to those whose homes have been targeted.

GO ON TO THE NEXT PAGE

Reasoning Through Language Arts, Section 1

We have determined not to meet this danger unprepared. The additional cost to double nighttime security patrols by Protect Pro will be approximately \$25,000 to \$30,000 annually. There are no additional funds in our budget available to cover such an unexpected, but necessary, expense. Therefore,

Select...	▼
concerning our community, as we all do	
as we all were concerned about our community,	
as we are all concerned about our community,	
having concern about our community, as were we all,	

I propose that every resident consider personally contributing to the security control budget. I am willing to spearhead this initiative with my own business. For every \$2 raised in the community to cover the additional security costs, IntelliTech will donate \$1 more.

Please make a donation today to support this much-needed cause for the common good. You can visit either one of our two stores and deposit your donation in the boxes provided near the front cash registers. Alternatively, if you can't make it to the store, please send a check or money order, payable to "ProtectPro Security Patrol" and mail

Select...	▼
them	
it	
that	
one	

With neighborly goodwill,

Gracie Wishton
IntelliTech Design
823 Askward St.
Laughing Pines, NJ

GO ON TO THE NEXT PAGE

Reasoning Through Language Arts, Section 2

Extended Response Answer Guidelines

Please use the guidelines below as you answer the Extended Response question on the Reasoning Through Language Arts test. Following these guidelines as closely as possible will ensure that you provide the best response.

1. **Please note that this task must be completed in no more than 45 minutes.** However, don't rush through your response. Be sure to read through the passage(s) and the prompt. Then think about the message you want to convey in your response. **Be sure to plan your response before you begin writing.** Draft your response and revise it as needed.
2. As you read, think carefully about the **argumentation** presented in the passage(s). "Argumentation" refers to the assumptions, claims, support, reasoning, and credibility on which a position is based. Pay close attention to **how the author(s) use these strategies to convey his or her (their) positions.**
3. When you write your essay, be sure to
 - **determine which position presented** in the passage(s) is **better supported** by evidence from the passage(s)
 - **explain why the position you chose is the better-supported one**
 - **remember, the better-supported position is not necessarily the position you agree with**
 - **defend your assertions with multiple pieces of evidence** from the passage(s)
 - **build your main points thoroughly**
 - **put your main points in logical order** and tie your details to your main points
 - **organize your response carefully** and consider your **audience, message, and purpose**
 - **use transitional words and phrases** to connect sentences, paragraphs, and ideas
 - **choose words carefully** to express your ideas clearly
 - **vary your sentence structure** to enhance the flow and clarity of your response
 - **reread and revise your response** to correct any errors in grammar, usage, or punctuation

GO ON TO THE NEXT PAGE

Reasoning Through Language Arts, Section 2

Instructions

Read

- On the **page 2 tab above**, you will **read two texts** presenting **different views** on the same topic.
- **Both writers argue** that **their position** on the issue is **correct**.

Plan

- **Analyze** the two texts **to determine** which writer presents the **stronger case**.
- **Develop your own argument** in which **you explain** how one position is **better supported** than the other.
- **Include** relevant and specific **evidence** from **both sources** to support your argument.

Write

- **Type** your response in the **box on the right**.
- Your response should be approximately **4 to 7 paragraphs of 3 to 7 sentences each**.
- **Remember** to allow a few minutes **to review and edit your response**.

You have up to **45 minutes** for reading, planning, writing, and editing your response.

Emissions Trading

- 1 “Cap-and-trade” is a market-based policy tool for controlling large amounts of harmful emissions, such as sulfur dioxide (SO₂) and nitrogen oxides (NO_x), from a group of sources. A cap-and-trade program from the Environmental Protection Agency (EPA) first sets an aggressive “cap,” or maximum limit, on emissions. Businesses and industries covered by the program then receive authorizations to produce emissions in the form of emissions permits, with the total amount of permits limited by the cap. Each business or industry can develop its own strategy to comply with the overall reduction requirement, including the sale or purchase (the “trade”) of permits, installation of pollution controls, and implementation of efficiency measures, among other options. Businesses and industries must also completely and accurately measure and report all emissions in a timely manner to guarantee that the overall cap is met.

GO ON TO THE NEXT PAGE

Reasoning Through Language Arts, Section 2

Indications That Cap-and-Trade Works

- 2 Under the right circumstances, cap-and-trade programs have proven extremely effective, providing certainty in allocations, rules, and penalties; substantial emission reductions; cost-effective, flexible compliance choices for regulated sources; complete accountability, unprecedented data quality, and public access to program data and decisions; and minimized administrative costs for industry and government. EPA's cap-and-trade programs have the force of federal and state standards behind them, including national health-based air quality standards. This ensures that local public health needs are met in conjunction with achievement of regional or national emission reductions.
- 3 Examples of successful cap-and-trade programs include the nationwide Acid Rain Program (ARP) and the regional NO_x Budget Trading Program in the Northeast. Additionally, EPA issued the Clean Air Interstate Rule (CAIR) on March 10, 2005, to build on the success of these programs and achieve significant additional emission reductions.
- 4 The programs have had measurable results:
 - Since the 1990s, SO₂ emissions have dropped 40%, and according to the Pacific Research Institute, acid rain levels have dropped 65% since 1976.
 - NO_x reductions due to the NO_x Budget Trading Program have led to improvements in ozone and particulate matter, saving an estimated 580 to 1,800 lives in 2008.
 - Ozone season NO_x emissions decreased by 43 percent between 2003 and 2008, even while energy demand remained essentially the same during the same period.
 - The EPA estimates that by 2010, the overall costs of complying with the program for businesses and consumers will be \$1 billion to \$2 billion a year, only one fourth of what was originally predicted.
- 5 Therefore, cap-and-trade has been proven to be effective in protecting human health and the environment. Successful cap-and-trade programs reward innovation, efficiency, and early action and provide strict environmental accountability without inhibiting economic growth.

Criticisms of Cap-and-Trade

- 6 Critics have several objections to cap-and-trade. Skeptical environmentalists have argued that reductions in emissions

GO ON TO THE NEXT PAGE

Reasoning Through Language Arts, Section 2

occurred due to broad trends unconnected to the program. For example, there were many other regulations that impacted emissions at the time the ARP was implemented. Therefore, the effectiveness of the emissions trading element of the ARP in reducing emissions has been questioned, since the EPA also used other regulations in conjunction with the ARP during the time period the emissions reduction took place.

- 7 “Carbon leakage” occurs when there is an increase in carbon dioxide emissions in one country as a result of an emissions reduction by a second country with a strict climate policy. If one country has a strict emissions policy that raises production costs, then production may move offshore to the cheaper country with lower standards, and global emissions will not be reduced. Furthermore, cheap “offset” carbon credits are frequently available from the less developed countries, where they may be generated by local polluters at the expense of local communities.
- 8 Regulatory agencies run the risk of issuing too many emission credits, which can result in a very low price on emission permits. This reduces the incentive for companies to cut back their emissions, since permits are cheap. On the other hand, issuing too few permits can result in an excessively high permit price. Another issue with cap-and-trade programs has been overallocation, whereby the cap is high enough that sources of emissions do not need to reduce their emissions.
- 9 The price and supply of permits can result in perverse incentives. If, for example, polluting firms are given free emission permits, this may create a reason for them not to cut their emissions. A firm making large cuts in emissions could then be granted fewer emission permits in the future. This perverse incentive can be alleviated if permits are sold, rather than given, to polluters.
- 10 Some environmentalists argue that offsets for emission reductions are not a substitute for actual cuts in emissions, and that offsets are an excuse for business as usual, since expensive long-term changes will not be made if there is a cheaper source of carbon credits. Environmental protection will require more radical change than the modest changes driven by pollution trading schemes. These critics advocate solutions that leave most remaining fossil fuels underground.

You may take a 10-minute break before proceeding to Section 3.

GO ON TO THE NEXT PAGE

Reasoning Through Language Arts, Section 3

Questions 18 through 25 refer to the following passage.

Niagara by Mark Twain

- 1 Niagara Falls is a most enjoyable place of resort. The hotels are excellent, and the prices not at all exorbitant. The opportunities for fishing are not surpassed in the country; in fact, they are not even equaled elsewhere. Because, in other localities, certain places in the streams are much better than others; but at Niagara one place is just as good as another, for the reason that the fish do not bite anywhere, and so there is no use in your walking five miles to fish, when you can depend on being just as unsuccessful nearer home. The advantages of this state of things have never heretofore been properly placed before the public.
- 2 The weather is cool in summer, and the walks and drives are all pleasant and none of them fatiguing. When you start out to “do” the Falls you first drive down about a mile, and pay a small sum for the privilege of looking down from a precipice into the narrowest part of the Niagara River. A railway “cut” through a hill would be as comely if it had the angry river tumbling and foaming through its bottom. You can descend a staircase here a hundred and fifty feet down, and stand at the edge of the water. After you have done it, you will wonder why you did it; but you will then be too late.
- 3 Then you drive over to Suspension Bridge, and divide your misery between the chances of smashing down two hundred feet into the river below, and the chances of having the railway-train overhead smashing down onto you. Either possibility is discomfiting taken by itself, but, mixed together, they amount in the aggregate to positive unhappiness.
- 4 When you have examined the stupendous Horseshoe Fall till you are satisfied you cannot improve on it, you return to America by the new Suspension Bridge, and follow up the bank to where they exhibit the Cave of the Winds.
- 5 Here I followed instructions, and divested myself of all my clothing, and put on a waterproof jacket and overalls. This costume is picturesque, but not beautiful. A guide, similarly dressed, led the way down a flight of winding stairs, which wound and wound, and still kept on winding long after the thing ceased to be a novelty, and then terminated long before it had begun to be a pleasure. We were then well down under the precipice, but still considerably above the level of the river.
- 6 We now began to creep along flimsy bridges of a single plank, our persons shielded from destruction by a crazy wooden railing, to which I clung with both hands—not because I was afraid, but because I wanted to. Presently the descent became steeper and the bridge flimsier, and sprays from the American Fall began

GO ON TO THE NEXT PAGE

Reasoning Through Language Arts, Section 3

to rain down on us in fast increasing sheets that soon became blinding, and after that our progress was mostly in the nature of groping. Now a furious wind began to rush out from behind the waterfall, which seemed determined to sweep us from the bridge, and scatter us on the rocks and among the torrents below. I remarked that I wanted to go home; but it was too late. We were almost under the monstrous wall of water thundering down from above, and speech was in vain in the midst of such a pitiless crash of sound.

- 7 In another moment the guide disappeared behind the deluge, and, bewildered by the thunder, driven helplessly by the wind, and smitten by the arrowy tempest of rain, I followed. All was darkness. Such a mad storming, roaring, and bellowing of warring wind and water never crazed my ears before. I bent my head, and seemed to receive the Atlantic on my back. The world seemed going to destruction. I could not see anything, the flood poured down savagely. I raised my head, with open mouth, and the most of the American cataract went down my throat. If I had sprung a leak now I had been lost. And at this moment I discovered that the bridge had ceased, and we must trust for a foothold to the slippery and precipitous rocks. I never was so scared before and survived it. But we got through at last, and emerged into the open day, where we could stand in front of the laced and frothy and seething world of descending water, and look at it. When I saw how much of it there was, and how fearfully in earnest it was, I was sorry I had gone behind it.

18. The author's overall tone in paragraph 1 is one of

A. fearful prediction.
B. ironic contrast.
C. appreciative description.
D. satisfied recollection.

19. Read this sentence from paragraph 2.

After you have done it, you will wonder why you did it; but you will then be too late.

Why does the author choose to conclude the paragraph with this sentence?

- A. to show how important it is to arrive at the falls on time
B. to offer advice to any readers who might consider visiting Niagara Falls
C. to show the narrator's acquaintance with the motives of the reader
D. to predict a tourist's feelings about the effort needed to view the site

20. Which quotation from the passage stands out in direct contrast to the main theme of the passage?

A. "The weather is cool in summer, and the walks and drives are all pleasant and none of them fatiguing."
B. "You can descend a staircase here a hundred and fifty feet down, and stand at the edge of the water."
C. "Either possibility is discomfoting taken by itself, but, mixed together, they amount in the aggregate to positive unhappiness."
D. "Here I followed instructions, and divested myself of all my clothing, and put on a waterproof jacket and overalls."

GO ON TO THE NEXT PAGE

Reasoning Through Language Arts, Section 3

21. In paragraph 6, the narrator says, “I remarked that I wanted to go home.” Which characteristic does this remark reveal about the narrator?

- A. homesickness
- B. melancholy
- C. apprehension
- D. nostalgia

22. Read the following sentences from paragraph 7.

Such a mad storming, roaring, and bellowing of warring wind and water never crazed my ears before. I bent my head, and seemed to receive the Atlantic on my back.

This detailed description of the author’s surroundings enhances the story by

- A. revealing the author’s predicament after falling into the Atlantic.
- B. further emphasizing the flimsy nature of the bridges the author must cross.
- C. showing the fury of the storm that catches the author off guard.
- D. using exaggeration to illustrate the volume of water the author experiences.

23. Which definition best matches the use of the phrase “in earnest” in paragraph 7?

- A. serious
- B. vigorous
- C. sincere
- D. ardent

24. Drag and drop the events into the chart to show the order in which they occur in the excerpt. (For this practice test, write the event letters in the chart.)

Order of Events



(a) Horseshoe Fall is included as a stop in the visit.

(b) The Suspension Bridge is described.

(c) The narrator mentions a view of the river.

(d) The narrator goes behind the falls.

25. Which fact can the reader infer about Niagara Falls?

- A. Part of it is located outside the United States.
- B. It is a good spot for fishing.
- C. It is a short drive from the exhibit of the Cave of the Winds.
- D. Hotels there are expensive.

GO ON TO THE NEXT PAGE

Reasoning Through Language Arts, Section 3

Questions 26 through 33 refer to the following article.

Excerpt from “State Lotteries”

By A. A. Milne

- 1 The popular argument against the State Lottery is an assertion that it will encourage the gambling spirit. The popular argument in favor of the State Lottery is an assertion that it is hypocritical to say that it will encourage the gambling spirit, because the gambling spirit is already amongst us. Having listened to a good deal of this sort of argument on both sides, I thought it would be well to look up the word “gamble” in my dictionary, and I can now tell you all about it.
- 2 To gamble, says my dictionary, is “to play for money in games of skill or chance.” Now, to me this definition is particularly interesting, because it justifies all that I have been thinking about the gambling spirit in connection with Premium Bonds. I am against Premium Bonds, but not for the popular reason. I am against them because there is so very little of the gamble about them. And now that I have looked up “gamble” in the dictionary, I see that I was right. The “chance” element in a state lottery is obvious enough, but the “game” element is entirely absent.
- 3 We play for money in games of skill or chance. But it isn’t only of the money we are thinking. We get pleasure out of the game. If you are only throwing dice, you are engaged in a personal struggle with another man, and you are directing the struggle to this extent, that you can call the value of the stakes, and decide whether to go on or to stop. And is there any man who, having made a fortune at Monte Carlo, will admit that he owes it entirely to chance? Will he not rather attribute it to his wonderful system, or if not to that, at any rate to his wonderful nerve, his perseverance, or his recklessness?
- 4 This, then, is the gambling spirit. It has its dangers, certainly, but it is not entirely an evil spirit. It is possible that the State should not encourage it, but it is not called upon to exorcise it. I am not sure that I should favor a State gamble, but my arguments against it would be much the same as my arguments against State cricket or the solemn official endowment of any other jolly game. However, I need not trouble you with those arguments now, for nothing so harmless as a State gamble has ever been suggested. Instead, we have from time to time a State lottery offered to us, and that is a very different proposition.

GO ON TO THE NEXT PAGE

Reasoning Through Language Arts, Section 3

- 5 For in a State lottery—with daily prizes of £50,000—the game (or gambling) element does not exist. Buy your £100 bond, as a thousand placards will urge you to do, and you simply take part in a cold-blooded attempt to acquire money without working for it. You can take no personal interest whatever in the manner of acquiring it. Somebody turns a handle, and perhaps your number comes out. More probably it doesn't. If it doesn't, you can call yourself a fool for having thrown away your savings; if it does—well, you have got the money.
- 6 Moreover, the State would be giving its official approval to the unearned fortune. In these days, when the worker is asking for a week of so many less hours and so many more shillings, the State would answer: "I can show you a better way than that. What do you say to no work at all, and £20 a week for it?" At a time when the one cry is "Production!" the State adds (behind its hand), "Buy a Premium Bond, and let the other man produce for you." After all these years in which we have been slowly progressing towards the idea of a more equitable distribution of wealth, the Government would show us the really equitable way; it would collect the savings of the many, and redistribute them among the few. Instead of a million ten-pound citizens, we should have a thousand ten-thousand-pounders and 999,000 with nothing. That would be the official way of making the country happy and contented. But, in fact, our social and political controversies are not kept alive by such arguments as these, nor by the answers which can legitimately be made to such arguments. The case of the average man in favor of State lotteries is, quite simply, that he does not like Dr. Clifford. The case of the average man against State lotteries is equally simple; he cannot bear to be on the same side as Mr. Bottomley.

Source: Abridged and adapted from "State Lotteries," *If I May*, A. A. Milne, London: Methuen & Co Ltd, 1920

GO ON TO THE NEXT PAGE

Reasoning Through Language Arts, Section 3

26. Drag and drop two statements that express Milne’s purposes for writing the essay into the empty boxes. (For this practice test, write the statement letters in the boxes below.)

Milne’s Purpose

(a) To propose a way to achieve a more equitable distribution of wealth

(b) To persuade the reader that playing a State Lottery isn’t really gambling

(c) To analyze the dual characteristics of the definition of the word “gamble”

(d) To argue that a State Lottery should be adopted

(e) To emphasize the dangers of gambling

27. Why does the author use the phrase “behind its hand” (paragraph 6)?
- A. to show that the idea of “no work at all” is shameful and should be kept discreet
 - B. to illustrate that the messages from the State are contradictory
 - C. to imply that the State functions like a human body, with hands to do its work
 - D. to show that gambling is illegal and conducted in secret

28. In paragraph 3, what role does the image of the gambler in Monte Carlo play in the passage?
- A. It establishes Monte Carlo as a place where fortunes are made.
 - B. It is an example of the personal struggle with chance discussed in the previous sentence.
 - C. It underscores the recklessness of gambling.
 - D. It illustrates the aspects of gambling discussed in the previous paragraph.

29. Read this sentence from paragraph 6.

“The case of the average man in favor of State lotteries is, quite simply, that he does not like Dr. Clifford.”

What can the reader infer from this sentence?

- A. Dr. Clifford is opposed to State lotteries.
- B. Dr. Clifford is a supporter of State lotteries.
- C. The average man is simple and unintelligent compared to Dr. Clifford.
- D. The average man would not favor anything represented by Dr. Clifford.

GO ON TO THE NEXT PAGE

Reasoning Through Language Arts, Section 3

30. Which detail in Milne’s essay supports the claim that people get pleasure out of games of skill and chance?
- A. “Somebody turns a handle, and perhaps your number comes out.” (paragraph 5)
 - B. “That would be the official way of making the country happy and contented.” (paragraph 6)
 - C. “...it justifies all that I have been thinking about the gambling spirit...” (paragraph 2)
 - D. “Will he not rather attribute it to his wonderful system, or if not to that, at any rate to his wonderful nerve...” (paragraph 3)
31. What is the impact of the use of the term “cold-blooded” in paragraph 5?
- A. It prejudices the reader to view those who play the lottery as ruthless.
 - B. It offers a contrast to the warm, engaged description of gambling in paragraph 3.
 - C. It underscores the evil nature of gambling discussed in paragraph 4.
 - D. It sets a tone for the scenario that leaves “999,000 with nothing” in paragraph 6.
32. In paragraph 3, the author addresses the reader with direct questions. How do the questions contribute to the development of the author’s essay?
- A. They raise issues that will be answered in the following paragraphs.
 - B. They illustrate that the nature of gambling is always in question and can never be conclusively defined.
 - C. They inspire the reader to consider the personal characteristics of a gambler.
 - D. They influence the reader to agree with the author’s point that “game” is essential to gambling.
33. What can the reader infer about the author’s opinions regarding Premium Bonds?
- A. The author would not vote in favor of them.
 - B. The author views them as an appropriate method for redistributing public funds.
 - C. The author feels that they are a prime example of gambling as defined in his dictionary.
 - D. The author thinks they encourage hypocrisy.

GO ON TO THE NEXT PAGE

Reasoning Through Language Arts, Section 3

Questions 34 through 41 refer to the following article.

Career Myths That Stop People Cold by Olivia Crosby

- 1 Some career myths are less about occupations than about the working world in general. Myths like these can derail a career search and sap motivation. Here are five common myths, and realities, about careers.
- 2 **Myth:** There is one perfect job for me.
- 3 **Reality:** There are many occupations—and many jobs—that you would enjoy. Focusing on finding a single, perfect career is not only intimidating, it’s limiting. If you’re like most people, you will have several jobs and careers in your life, and each will have positive and negative aspects to it. Furthermore, your job preferences are apt to change over time as you gain experience, skill, and self-knowledge. Keeping your options open is a position of strength, not weakness.
- 4 **Myth:** I will use all of my talents and abilities in this job.
- 5 **Reality:** No one job uses all of your talents. And trying to find one that does will derail your job search. Learning a variety of tasks helps you to sharpen abilities that might not be needed in one job but could be invaluable in another. Especially at the start of your career, you should expect to spend time acquiring experience and skills. This is one reality about careers that, career counselors say, many new graduates fail to grasp. Counselors remind jobseekers to be patient. New workers should expect to start in entry-level positions and be willing to do routine tasks as they gain experience.
- 6 **Myth:** My job has to match my college major or vocational training.
- 7 **Reality:** You need not restrict your job search to careers related to your degree or training. Most jobs do not specify which college major is needed, even if they require that workers have a college degree. Many computer specialist positions, for example, are filled by workers whose degree is in a subject unrelated to computers. Vocational training is often more closely related to specific occupations. But even this kind of training can open the door to a wider array of jobs than people think. Consider that electrical technicians are now repairing fuel cells, for example, or that veterinary technicians become pharmaceutical sales workers. Often, technical skills are applicable to many settings—and most workers learn the specifics of an occupation on the job.

GO ON TO THE NEXT PAGE

Reasoning Through Language Arts, Section 3

- 8 **Myth:** No one will hire me because I lack experience, have low grades, have gaps in my work history, etc.
- 9 **Reality:** People overcome all kinds of challenges to find satisfying work. Experts say that how you handle adversity is a good indicator of your ability to persevere. Need experience? Get it! Volunteer, work in a related occupation, or focus on school projects that are relevant to your desired career. Low grades are the problem? Highlight other parts of your resume, and remember that grades usually matter only for that first job after graduation. Gaps in your work history? Overcome them with a well-designed resume that focuses on skills rather than chronology, and then get a little interviewing practice. For most entry-level jobs, employers are looking for general attributes such as communication skills, interpersonal abilities, and enthusiasm.
- 10 **Myth:** It's too late to change my career.
- 11 **Reality:** It's never too late to change careers. Workers who change careers come from many backgrounds, age groups, and situations. There's the doctor who decided she'd rather be a chef, the retiree who enrolled in college to become an accountant, the construction worker who wanted a steadier income without moving to a warmer climate. For each of these workers, the desire for job satisfaction outweighed the desire for status quo. To make the change easier, look at your past work and education to see what skills relate to the job you want. Most jobs' entry requirements are more flexible than people think. Gain needed skills with volunteer work, internships, or a class, and don't be afraid to start at the bottom to get the career you want. If you are out of school and want expert advice, consider a local One-Stop Career Center or the counseling center at a nearby school.

Source: U.S. Department of Labor, Bureau of Labor Statistics

GO ON TO THE NEXT PAGE

Reasoning Through Language Arts, Section 3

34. The author's tone toward the reader is one of

- A. condescension.
- B. reassurance.
- C. intimidation.
- D. satisfaction.

35. What is the author's primary purpose in writing this article?

- A. to encourage readers to develop new abilities and seek new experiences
- B. to caution workers against changing jobs by exposing the myths about career change
- C. to showcase the types of jobs that will accept workers with low grades and work history gaps
- D. to encourage job seekers to use all of their prior experience and training

36. Read this sentence from paragraph 7:

Consider that electrical technicians are now repairing fuel cells, for example, or that veterinary technicians become pharmaceutical sales workers.

The sentence enhances the article by

- A. giving examples of the types of careers readers should pursue.
- B. presenting a scenario to illustrate the fact that readers should apply for jobs that match their college majors.
- C. emphasizing the value and versatility of technical skills in the job market.
- D. offering an example to show that skills acquired in one kind of training can be transferred to another field.

37. In paragraph 9, the author asks and answers a series of questions. How does the question-and-answer structure help the author's point?

- A. It shows that gaps in work history are no worse than low grades.
- B. It supports the point in the next paragraph that it's never too late to change careers.
- C. It shows that the concerns raised in the previous paragraph can be addressed.
- D. It raises concerns that readers may not have considered.

38. Which definition best matches the use of the word "overcome" in paragraph 9?

- A. overpower
- B. shock
- C. outlive
- D. surmount

39. Read this sentence from paragraph 11:

For each of these workers, the desire for job satisfaction outweighed the desire for status quo.

What can be inferred about the "workers" in this sentence?

- A. They had all undergone a significant change in work.
- B. They were concerned with staying in a familiar field.
- C. They liked the status that came from professional jobs.
- D. They returned to school in order to widen their career options.

GO ON TO THE NEXT PAGE

Reasoning Through Language Arts, Section 3

40. The author claims that prospective employees can take steps to better their odds of employment. Drag two actions that the author uses to support this claim into the boxes below. (For this practice test, write the action letters in the boxes.)

--	--

(a) Work for good grades in college to make up for lack of experience

(b) Donate your time to charitable organizations

(c) Apply for jobs within your college major to increase your odds of landing a job

(d) Carefully explain gaps in work history

(e) Anticipate questions that might arise when applying for a job

41. What can the reader infer about the article's intended audience?
- A. The article is written specifically for first-time job seekers.
 - B. The article is written to students currently in college.
 - C. The article is written to help those who are uncertain about finding a job.
 - D. The article is written to help job seekers address gaps in their work history.

GO ON TO THE NEXT PAGE

Reasoning Through Language Arts, Section 3

Questions 42 through 49 refer to the following article.

Susan B. Anthony: Rebel, Crusader, Humanitarian by Alma Lutz

- 1 “If Sally Ann knows more about weaving than Elijah,” reasoned eleven-year-old Susan with her father, “then why don’t you make her overseer?”
- 2 “It would never do,” replied Daniel Anthony as a matter of course. “It would never do to have a woman overseer in the mill.”
- 3 This answer did not satisfy Susan and she often thought about it. To enter the mill, to stand quietly and look about, was the best kind of entertainment, for she was fascinated by the whir of the looms, by the nimble fingers of the weavers, and by the general air of efficiency. Admiringly she watched Sally Ann Hyatt, the tall capable weaver from Vermont. When the yarn on the beam was tangled or there was something wrong with the machinery, Elijah, the overseer, always called out to Sally Ann, “I’ll tend your loom, if you’ll look after this.” Sally Ann never failed to locate the trouble or to untangle the yarn. Yet she was never made overseer, and this continued to puzzle Susan.
- 4 The manufacture of cotton was a new industry, developing with great promise in the United States, when Susan B. Anthony was born on February 15, 1820, in the wide valley at the foot of Mt. Greylock, near Adams, Massachusetts. Enterprising young men like her father, Daniel Anthony, saw a potential cotton mill by the side of every rushing brook, and young women, eager to earn the first money they could call their own, were leaving the farms, for a few months at least, to work in the mills. Cotton cloth was the new sensation and the demand for it was steadily growing. Brides were proud to display a few cotton sheets instead of commonplace homespun linen.
- 5 When Susan was two years old, her father built a cotton factory of twenty-six looms beside the brook which ran through Grandfather Read’s meadow, hauling the cotton forty miles by wagon from Troy, New York. The millworkers, most of them young girls from Vermont, boarded, as was the custom, in the home of the millowner; Susan’s mother, Lucy Read Anthony, although she had three small daughters to care for, Guelma, Susan, and Hannah, boarded eleven of the millworkers with only the help of a thirteen-year-old girl who worked for her after school hours. Lucy Anthony cooked their meals on the hearth of

GO ON TO THE NEXT PAGE

Reasoning Through Language Arts, Section 3

the big kitchen fireplace, and in the large brick oven beside it baked crisp brown loaves of bread. In addition, washing, ironing, mending, and spinning filled her days. But she was capable and strong and was doing only what all women in this new country were expected to do. She taught her young daughters to help her, and Susan, even before she was six, was very useful; by the time she was ten she could cook a good meal and pack a dinner pail.

42. How does being told “it would never do to have a woman overseer in the mill” affect young Susan?
- A. She sees the truth of the words after she watches the workers in the mill.
 - B. She questions her father’s judgment.
 - C. She learns that what she is told does not always match her observations.
 - D. She decides to go to work in the mill to rebel against her father.
43. How do the details about Susan’s home life in paragraph 5 enhance the narrative?
- A. They give a portrait of the kinds of work customary for women at the time.
 - B. They reveal how overworked Susan’s mother was because her father was away building the cotton factory.
 - C. They show that working at home was much harder than working in the mill.
 - D. They demonstrate how difficult it was to board the millworkers.
44. Which quotation from the passage supports the idea that Susan is learning skills that enhance independence?
- A. “young women, eager to earn the first money they could call their own, were leaving the farms”
 - B. “Sally Ann never failed to locate the trouble or to untangle the yarn.”
 - C. “she was fascinated by the whir of the looms, by the nimble fingers of the weavers, and by the general air of efficiency.”
 - D. “by the time she was ten she could cook a good meal and pack a dinner pail.”
45. In this excerpt the overseer speaks to Sally Ann when there is trouble with the machinery. What does this action reveal about Sally Ann?
- A. She is a more efficient weaver than the other women who work at the factory, which suggests that she is the best person to be overseer.
 - B. Her mechanical aptitude is recognized by the other workers, which suggests that she would be a competent overseer.
 - C. She has a habit of getting in trouble for tangling the yarn in her machinery, which confirms Susan’s father’s statement that she should not be overseer.
 - D. She enjoys being asked for help, which shows she hopes to be made overseer someday.

GO ON TO THE NEXT PAGE

Reasoning Through Language Arts, Section 3

46. Based on the story, what was Susan's father's attitude about the cotton mills?
- A. The mills were an acceptable place for women to work.
 - B. The new cotton industry only had places for enterprising young men.
 - C. Cotton cloth made in the mills would be sure to replace homespun entirely, creating new jobs for both women and men.
 - D. He thought of the mills as places that proved that men were generally more efficient than women.
47. Drag and drop into the character web each word that describes Susan as she watches the mill workers. (For this practice test, write the words in the web.)

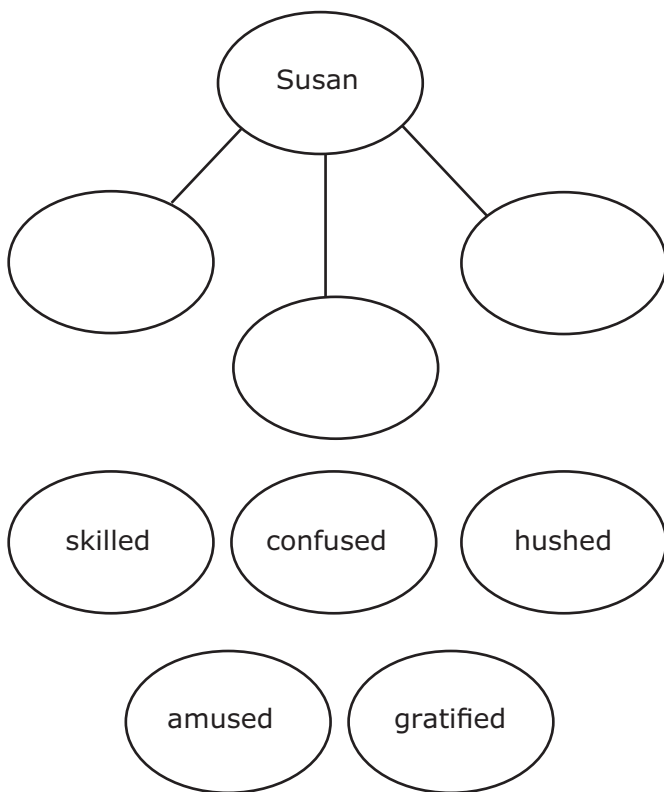

48. What can readers infer about the mill that Susan's father built?
- A. It was located in Troy, New York, to take advantage of industrial development.
 - B. It was staffed by workers who boarded at the mill.
 - C. Construction on the mill was begun in 1820 in a valley.
 - D. It had to be located near a source of running water.
49. Based on the details in the story, what can readers tell about the women workers in Susan's father's mill?
- A. Most of the weavers were qualified to become overseers.
 - B. For some of them, the job at the mill was their first paying job.
 - C. They lived on farms and traveled to their jobs in the mill.
 - D. They helped Susan's mother with the housework.

GO ON TO THE NEXT PAGE

Reasoning Through Language Arts, Section 3

50. The passage below is incomplete. For each “Select” option, choose the option that correctly completes the sentence. (For this practice test, circle your selection.)

August 25, 2010

Ms. Roberta Alvarez
Manager, Marketing Services
Zetacorp, Inc.
554 Alacor Drive
Stamford, CT 06907

Dear Ms. Alvarez:

In response to your request, I am writing to provide a letter of recommendation for Jorge Garcez who worked for me until last year. Jorge Garcez worked in my department under my direct supervision at Readywise ImageGraphics for a period of six years ending in June 2009.

Select...	▼
During that period, it is with great pleasure that I see him developing	
During that period, I had the great pleasure of seeing him develop	
Seeing him develop during that period, I had great pleasure	
As I saw him during that period, with great pleasure, he was developing	

from a paste-up assistant at the beginning, into a fully functioning Graphics Design Project Coordinator in his final two years with the company. That was the last position he held before moving on to a better career opportunity elsewhere.

Jorge is a hard-working self-starter who invariably understands exactly what a project is all about from the outset, and how to get it done

Select...	▼
quickly and effectively, during	
quickly, effectively, and during.	
quickly and effectively. During	
quick and effectively. During	

his two years as Graphics Design Project Coordinator, he met every deadline, often ahead of schedule. His projects were

GO ON TO THE NEXT PAGE

Reasoning Through Language Arts, Section 3

rendered with the utmost quality, requiring very little revision after the first presentation. He was very budget-minded, finding creative ways to fund his team's needs within the allocated funds. Resourceful, creative, and solution-oriented, Mr. Garcez often found innovative and refreshing approaches to the challenges involved in his everyday tasks. He is flexible as a team

Select...	▼
worker, able to give guidance and step	
worker. Just as able to give guidance and step	
worker, just as able to give guidance and stepping	
worker, just as able to give guidance as to step	

back and take direction when another is leading the group.

Jorge's written and communication skills are excellent, and he was well liked by everyone on our staff. He served as a mediator on our interdepartmental committee to ensure smooth cooperation from all project levels, helping department heads communicate their needs to one another. On the interpersonal side, Mr. Garcez gets along well with all colleagues, customers, and even competitors!

When he told us, regretfully, that he was leaving to fill a new position with a larger company, we were saddened to see him leave. Still, we wished him success and happiness in his new position and endeavors.

Select...	▼
Even a year after his resignation, still, he is remembered here fondly.	
A year after his resignation, even he is still remembered fondly here.	
He is remembered here still fondly, even a year after his resignation.	
He is still remembered fondly here, even a year after his resignation.	

Therefore, I can recommend Jorge Garcez most heartily to fill any senior graphic design position you might have. I hope these details have illuminated Mr. Garcez's capabilities. If I can provide any further information, please feel free to call me at (417) 555-4495.

Sincerely,

Rita Cassat
Senior Vice President
Readywise ImageGraphics

GO ON TO THE NEXT PAGE

Mathematical Reasoning

Welcome!

Here is some information that you need to know before you start this test:

- You should not spend too much time on a question if you are not certain of the answer; answer it the best you can, and go on to the next question.
- If you are not certain of the answer to a question, you can mark your answer for review and come back to it later.
- You have **115 minutes** to complete this test.
- This test has two parts.
- When you finish Part 1, you may review those questions.
- You may not go back to Part 1 once you have finished your review.
- You may not use a calculator in Part 1. You may use a calculator in Part 2.

Turn the page to begin.

GO ON TO THE NEXT PAGE

Mathematics Formula Sheet

Area of a:

square $A = s^2$

rectangle $A = lw$

parallelogram $A = bh$

triangle $A = \frac{1}{2}bh$

trapezoid $A = \frac{1}{2}h(b_1 + b_2)$

circle $A = \pi r^2$

Perimeter of a:

square $P = 4s$

rectangle $P = 2l + 2w$

triangle $P = s_1 + s_2 + s_3$

Circumference of a circle $C = 2\pi r$ OR $C = \pi d$; $\pi \approx 3.14$

Surface Area and Volume of a:

rectangular prism $SA = 2lw + 2lh + 2wh$ $V = lwh$

right prism $SA = ph + 2B$ $V = Bh$

cylinder $SA = 2\pi rh + 2\pi r^2$ $V = \pi r^2 h$

pyramid $SA = \frac{1}{2}ps + B$ $V = \frac{1}{3}Bh$

cone $SA = \pi rs + \pi r^2$ $V = \frac{1}{3}\pi r^2 h$

sphere $SA = 4\pi r^2$ $V = \frac{4}{3}\pi r^3$

(p = perimeter of base B ; $\pi \approx 3.14$)

Data

mean mean is equal to the total of the values of a data set, divided by the number of elements in the data set

median median is the middle value in an odd number of ordered values of a data set, or the mean of the two middle values in an even number of ordered values in a data set

Algebra

slope of a line $m = \frac{y_2 - y_1}{x_2 - x_1}$

slope-intercept form of the equation of a line $y = mx + b$

point-slope form of the equation of a line $y - y_1 = m(x - x_1)$

standard form of a quadratic equation $y = ax^2 + bx + c$

quadratic formula $x = \frac{-b \pm \sqrt{b^2 - 4ac}}{2a}$

Pythagorean Theorem $a^2 + b^2 = c^2$

simple interest $I = prt$
(I = interest, p = principal, r = rate, t = time)

distance formula $d = rt$

total cost total cost = (number of units) \times (price per unit)

GO ON TO THE NEXT PAGE

Mathematical Reasoning, Part 1

You may NOT use a calculator in Part 1.

- If $z = -3$, what is $\frac{z^3 + 2z + 3}{z^2 + 1}$?
 - 3
 - 1.8
 - 3.6
 - 3
- Each of 4 CDs can contain up to 3.6 hours of recorded music. If each of the CDs is at least half full, which of the following expressions represents the total amount of music, x , contained on all 4 CDs?
 - $0 < x < 7.2$
 - $0 < x < 14.4$
 - $7.2 < x < 14.4$
 - $1.8 < x < 3.6$
- Traveling at an average speed of 58 miles per hour, Terence drives 145 miles. Three hours later, Terence makes the return trip at the same speed. How much total time elapses between Terence's original departure and final return?
 - 2.5 hours
 - 5 hours
 - 5.5 hours
 - 8 hours
- The average temperature, in degrees Fahrenheit, in the month of July in Clark City is 4 times the average temperature in the month of February. If the average temperature in July was 82 degrees, which of the following equations could be used to determine the average temperature in February (t)?
 - $t + 4 = \frac{82}{4}$
 - $4t = 82$
 - $\frac{t}{4} = 21$
 - $4t = 21$
- If 20% of a shipment of 50,000 tomatoes is crushed during transport and then 5% of the remaining tomatoes are lost to insects, then how many tomatoes remain?

GO ON TO THE NEXT PAGE

Mathematical Reasoning, Part 2

You MAY use a calculator in Part 2.

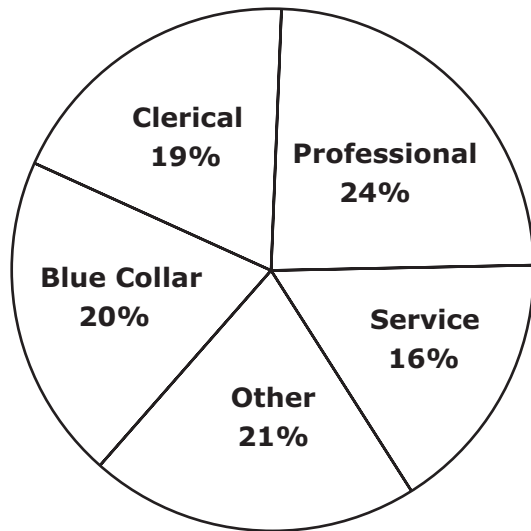

6. The figure above shows the worker distribution in a given country. If the total population of workers is 2.3 million, how many workers are employed neither in clerical nor in professional occupations?

A. 1,311,000
B. 1,048,800
C. 990,000
D. 552,000

7. Miriam and Betty buy a total of 42 stamps. Miriam bought 6 more stamps than Betty did. How many stamps did Miriam buy?

A. 18
B. 24
C. 30
D. 36

Questions 8 and 9 refer to the following number line.

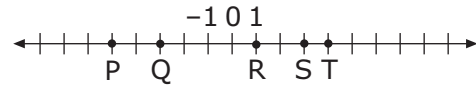

8. Select the point on the number line that corresponds to the value $P + S$. (For this practice test, mark the point with an X.)
9. Select the point on the number line that corresponds to $|Q - R| - T$. (For this practice test, mark the point with an X.)
10. Since its formation 10,000 years ago, Niagara Falls has eroded upstream a distance of 9.8 miles. Which of the following equations indicates the distance D that Niagara Falls, continuing at this rate, will erode in the next 22,000 years?
- A. $\frac{9.8}{10,000} = \frac{D}{22,000}$
- B. $\frac{9.8}{10,000} = \frac{D}{12,000}$
- C. $D = 9.8 + \frac{22,000}{10,000}$
- D. $D = 9.8 \times \frac{10,000}{22,000}$

GO ON TO THE NEXT PAGE

Mathematical Reasoning, Part 2

11. A science class compares the relative strength of two telescopic lenses. Lens X produces a magnification of 3×10^5 , and Lens Y produces a magnification of 6×10^2 .

Which of the following statements accurately describes the relationship between the two lenses?

- A. Lens X produces a magnification 200% that of lens Y.
- B. Lens X is 200 times as strong as Lens Y.
- C. Lens X produces a magnification 500% that of lens Y.
- D. Lens X is 500 times as strong as Lens Y.
12. If Mark can mow $\frac{2}{3}$ of a lawn in 1 hour, how many hours does it take him to mow the entire lawn?
- A. $\frac{2}{3}$
- B. $1\frac{1}{3}$
- C. $1\frac{1}{2}$
- D. 2

Question 13 refers to the diagram below.

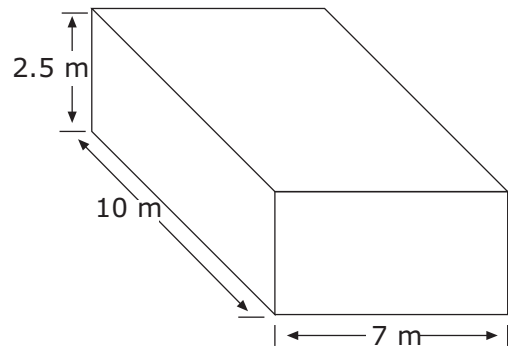

13. The dimensions of a box are shown in the diagram above. A designer wishes to paint the four larger sides of the box, leaving the smallest two sides unpainted. What will be the total surface area in square meters of the four sides the designer paints?
- A. 175
- B. 190
- C. 225
- D. 280
14. Evaluate $3x(x - 2a)^{-x}$, if $x = -2$ and $a = 0.5$.



GO ON TO THE NEXT PAGE

Mathematical Reasoning, Part 2

Question 15 is based on the following figure.

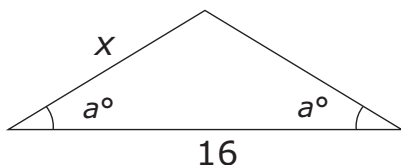

15. Given that the triangle above is an isosceles triangle, if side $x =$, then the perimeter
- | |
|----|
| 9 |
| 10 |
| 13 |
| 16 |

of the triangle will be .

27
31
34
41

16. Mrs. Carter decides to buy a computer system for her son. She spends \$1,500 for a computer and LCD monitor, \$650 for a color laser printer, and \$250 for an external hard drive. What would be the total cost of the system if the cost of the computer and monitor cost 10% more?

17. Universal Products has 78 employees. If twice as many women work for Universal as men, how many women work for Universal?
- A. 52
 B. 42
 C. 26
 D. 16

18. In a study of bird migration, a researcher recorded, on a certain day a total of 262 birds, consisting of 65 geese, 84 ducks, and 113 robins in the skies. Below, show a possible equation for calculating the probability that a random bird chosen from among these is not a duck. (For this practice test, write the numbers in the boxes below.)

	+	
<div style="border: 1px solid black; width: 80px; height: 20px; margin: 0 auto;"></div>		
<div style="border: 1px solid black; width: 80px; height: 20px; margin: 0 auto;"></div>		
<div style="border: 1px solid black; width: 80px; height: 20px; margin: 0 auto;"></div>		
<div style="border: 1px solid black; width: 80px; height: 20px; margin: 0 auto;"></div>		
<div style="border: 1px solid black; width: 80px; height: 20px; margin: 0 auto;"></div>		

19. Which of the following expressions is equivalent to $2a(a - 3b^2) + a^2$?
- A. $2a^2 - 6ab^2$
 B. $3a^2 - 3b^2$
 C. $2a(a - 3b^2)$
 D. $3a(a - 2b^2)$

GO ON TO THE NEXT PAGE

Mathematical Reasoning, Part 2

Questions 20 and 21 are based on the following graph.

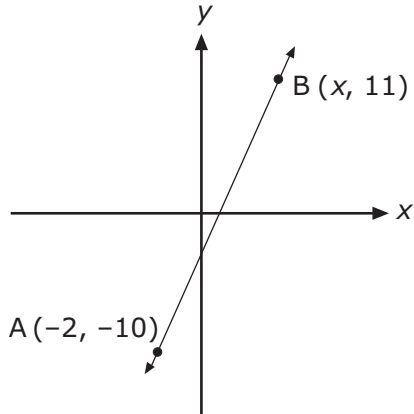

20. If the slope of the line shown is 3, then what is the x -coordinate of point B?
- A. -5
 - B. -3
 - C. 3
 - D. 5
21. Given that the slope of the line is 3, what is the equation of the line?
- A. $y = 3x - 3$
 - B. $y = 3x - 4$
 - C. $y = 3x - 5$
 - D. $y = 3x - 10$
22. Working for 4 hours a day, a typist earns \$65.40 a day after taxes. At the same rate of pay, what would he earn per day if he worked for 7 hours a day? (Let N represent after-tax earnings.)
- A. $N = \frac{4}{7}(65.40)$
 - B. $N = \frac{7}{4}(65.40)$
 - C. $N = 4(65.40)$
 - D. $N = 7(65.40)$

GO ON TO THE NEXT PAGE

Mathematical Reasoning, Part 2

Questions 23 and 24 refer to the following graph.

Movie Survey, by %

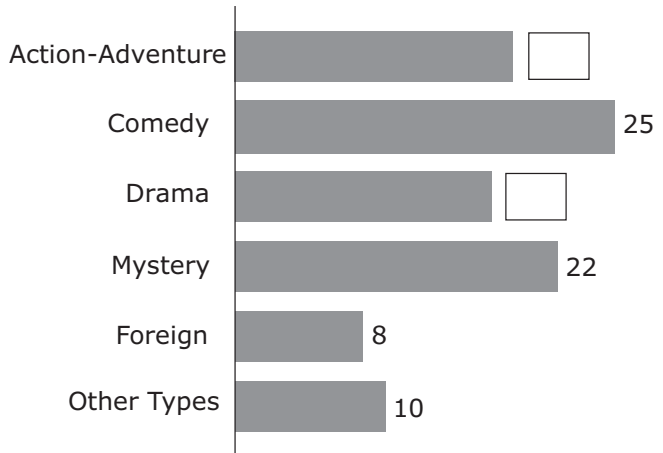

23. The graph above shows the results of a survey that asked moviegoers to choose their favorite type of movie. If the chart represents all the people surveyed and if each person chose only one type of movie, then choose two numbers below that could properly complete the graph, showing values for Action-Adventure and for Drama. (For this practice test, write the numbers in the boxes.)

Action-Adventure	Drama

--	--	--

- | | | |
|----|----|----|
| 10 | 15 | 17 |
| 18 | 19 | 25 |

24. Which of the following correctly represents the ratio of Comedy to Other Types, as given in the bar graph?

- A. 5:2
- B. 25:12
- C. 2:5
- D. 12:25

25. Tickets for a train trip sell for the following prices:

First-class tickets \$6.00
Second-class tickets \$3.50

Which of the following expressions represents the average ticket price for all tickets sold if the station sells 110 first-class and 172 second-class tickets?

- A. $\frac{110 + 172}{2}$
- B. $\frac{110(6.00) + 172(3.50)}{2}$
- C. $\frac{(110+172) + 4.75}{110+172}$
- D. $\frac{110(6.00) + 172(3.50)}{110 + 172}$

26. If $y = \frac{1}{2}x + 3$ and $x > 0$, then $x =$

GO ON TO THE NEXT PAGE

Mathematical Reasoning, Part 2

Question 27 refers to the following diagram.

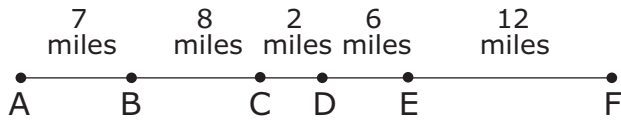

27. The towns in Maple County are located along a 35-mile section of an interstate at the points A, B, C, D, E, and F as shown in the diagram above. The Maple County Post Office is located midway between points A and E. The location of the post office is between which of the following two points?

- A. D and E
- B. C and D
- C. B and C
- D. A and B

28. The total bill for four friends eating at a restaurant (including tax) is \$36.00. The friends wish to add a 20% tip and then to divide the bill evenly among the four of them. How much will each person pay?

- A. \$7.20
- B. \$9.00
- C. \$10.80
- D. \$16.20

Question 29 refers to the following coordinate plane grid.

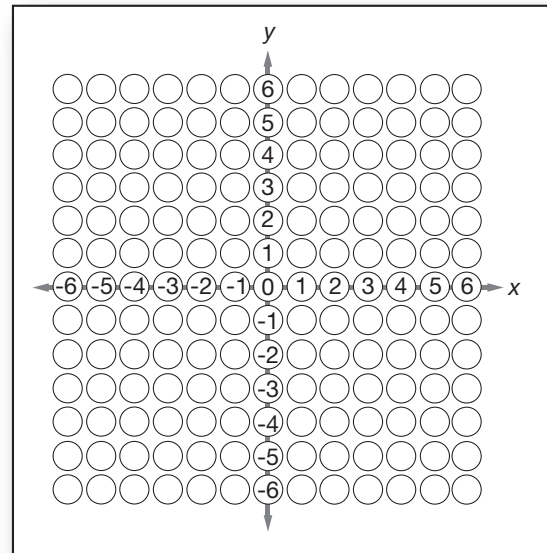

29. If the equation of a line is $y = \frac{1}{2}x + 3$, then mark on the graph the point where the line crosses the y-axis and the point where the line crosses the x-axis.

30. Karen puts 60% of her paycheck into her savings account. If Karen put \$120 into her savings account, what was the amount of her entire paycheck?

GO ON TO THE NEXT PAGE

Mathematical Reasoning, Part 2

31. A rainfall doubled the original amount of water in a reservoir in 1 day and quadrupled the original amount in 5 days. Which of the following expressions represents the approximate amount of water in the reservoir after the 5 days of rain, if there were x gallons of water in the reservoir before the rainfall?

A. $x + 4$
B. $x + 6$
C. $4x$
D. $5x$

32. At Lakeside Park restaurant, servers earn an average of \$840 less per month than chefs. The restaurant employs 4 chefs and 18 servers. Let c represent the average monthly pay of a chef. Which of the following functions correctly shows the relationship between the monthly payroll (P) and the wages of these employees?

A. $4c + 18c - 840$
B. $4(c - 840) + 18c$
C. $22c - 840$
D. $4c + 18(c - 840)$

33. The town of Woodgreen offers billboard space along the highway. A 5 foot by 8 foot rectangular advertising space costs \$140. The price (p) of a sign is proportional to its area. A new sign erected in the billboard space costs \$336. If the new sign is 8 feet tall, then what is its length?

A. 11 feet
B. 12 feet
C. 16 feet
D. 42 feet

34. Team A has won 28 of 35 games so far this season. There are a total of 44 games in the entire season. How many of the remaining games must team A win in order to have an overall win percentage of 75%?

A. 3
B. 5
C. 9
D. 33

Question 35 refers to the following diagram.

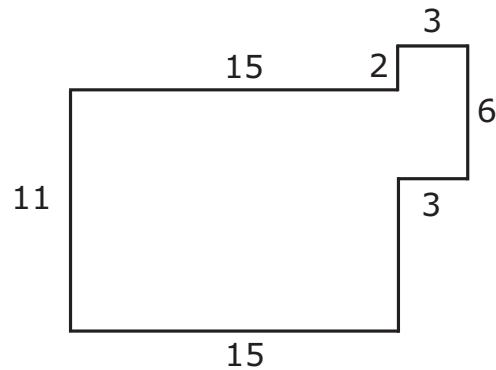

35. What is the area of the figure above?

A. 55
B. 132
C. 165
D. 183

36. A certain chest (a rectangular solid) has the following dimensions: 1.5 feet wide, 2.5 feet long, and 2 feet deep. If the chest currently holds 3 blankets that individually occupy 1 cubic foot each, then how much additional space is available in the chest?



GO ON TO THE NEXT PAGE

Mathematical Reasoning, Part 2

37. Michelle had a medical bill of \$850. After she paid the deductible of \$500, her insurance company paid 80% of the remainder. How much more of the bill did Michelle have to pay?

- A. 70
- B. 100
- C. 170
- D. 280

40. An airplane can hold 325 passengers, 30 in first class and the rest in coach. If a first-class ticket costs \$700 and a coach ticket costs \$250, then what is the minimum revenue that the airplane will gross on a flight in which exactly 3 seats remain empty?

Questions 38 and 39 refer to the following diagram.

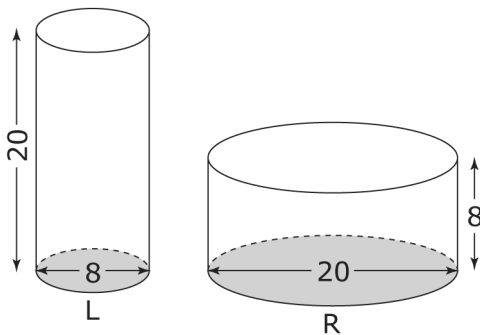

Questions 41 and 42 refer to the following number line.

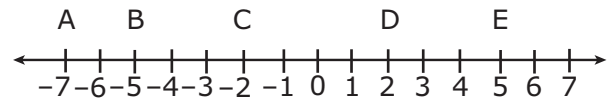

41. Let x be the distance between points A and E as shown on the number line above. Indicate where the point $\frac{x}{3}$ would appear on the number line. (For this practice test, write an X on the number line.)

42. Indicate where on the number line the point $(B - C) - D$ would appear. (For this practice test, write an X on the number line.)

38. The volume of cylinder L is

Select...	▼
less than half	
slightly smaller than	
equal to	
slightly larger than	
more than twice	

the volume of cylinder R.

39. If cylinder L is filled with water and then emptied into cylinder R (which was previously empty), then what will the height of the water in cylinder R be?

- A. 3.2
- B. 4
- C. 4.6
- D. 8

GO ON TO THE NEXT PAGE

Mathematical Reasoning, Part 2

Question 43 refers to the following diagram.

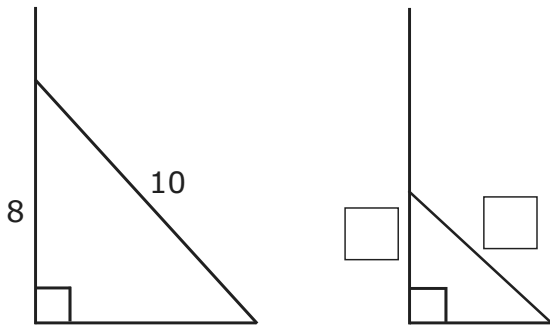

43. Two poles of different lengths are placed against a wall at identical angles, forming two similar triangles. Select two numbers from those below that give possible values for the length of the shorter pole and the height up the wall that it reaches. (For this practice test, write the numbers in the boxes above.)

4	5	6
8	11	

44. AJ was prescribed an antibiotic that must be taken as one tablet every 8 hours. Following the instructions, he took the first tablet at 2 pm on Monday and took the last tablet three days later, on Thursday at 2 pm. How many tablets of antibiotic did AJ take?

45. Over an 8-year period, Katrina's \$14,000 investment in the stock market increased by 180%. What was the value of her investment at the end of that period?
- A. \$16,520
 B. \$25,200
 C. \$39,200
 D. \$252,000

Question 46 refers to the following diagram.

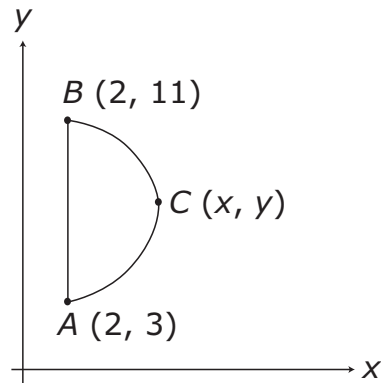

46. For the semicircle above, point C represents the midpoint of arc AB . Which of the following represent the coordinates of point C ?
- A. $(6, 7)$
 B. $(7, 7)$
 C. $(4, 6)$
 D. $(7, 6)$

GO ON TO THE NEXT PAGE

Social Studies

Welcome!

Here is some information that you need to know before you start this test:

- You should not spend too much time on a question if you are not certain of the answer; answer it the best you can, and go on to the next question.
- If you are not certain of the answer to a question, you can mark your answer for review and come back to it later.
- You have **70 minutes** to complete this test.

Turn the page to begin.

GO ON TO THE NEXT PAGE

Social Studies

Questions 1 through 3 are based on the following information.

The Department of Labor operates under the mandate that the most important capital is human capital. The Fair Labor Standards Act (FLSA), which also sets minimum wage and overtime pay standards in the private and government sectors, has specific provisions designed to protect children—the future workforce of America. Employment for minors now must conform to the following restrictions, which apply to all labor except farm labor. First, 16- or 17-year-olds may legally obtain employment as long as the job is not determined to be dangerous or ruinous to their health or well-being. Second, 14- or 15-year-olds may also work during specific hours at certain jobs as long as their employment does not negatively affect their health, schooling, or well-being. Employment of children under 14 years of age is usually prohibited. The Department of Labor has already classified 17 nonagricultural occupations as being unsuitable for minors.

1. According to the regulations described, all of the following could legally be used to deny a minor employment EXCEPT
 - A. age.
 - B. gender.
 - C. hazard level.
 - D. type of job.
2. Which of the following beliefs is the basis for the regulations?
 - A. Minors should judge the appropriateness of their own employment.
 - B. Employment of minors must be controlled to protect them from harm.
 - C. Minors should not be employed under any circumstances.
 - D. School children should focus on their studies and not be burdened with jobs.
3. The most support for the passage of the FLSA likely came from
 - A. factory owners.
 - B. child protection agencies.
 - C. workers' unions.
 - D. small companies.

GO ON TO THE NEXT PAGE

Social Studies

Questions 4 through 6 refer to the following sources.

TAB 1: Timeline of events following the end of World War II

1945: Yalta Conference: The Allies of World War II (the USA, the USSR, Great Britain, and France) divide Germany into four occupation zones.

1947: Marshall Plan: A comprehensive program of economic assistance for the war-ravaged countries of Western Europe.

1948: Berlin Airlift: In response to Soviet Premier Joseph Stalin's attempt to block supplies to Berliners, France, Britain, and the United States launch the Berlin Airlift to supply the citizens of Berlin by air.

1949: North Atlantic Treaty Organization (NATO): Western nations unite in order to resist Communist expansion.

1955: Warsaw Pact: Soviet Union and Eastern European Communist nations unite to oppose NATO.

TAB 2:

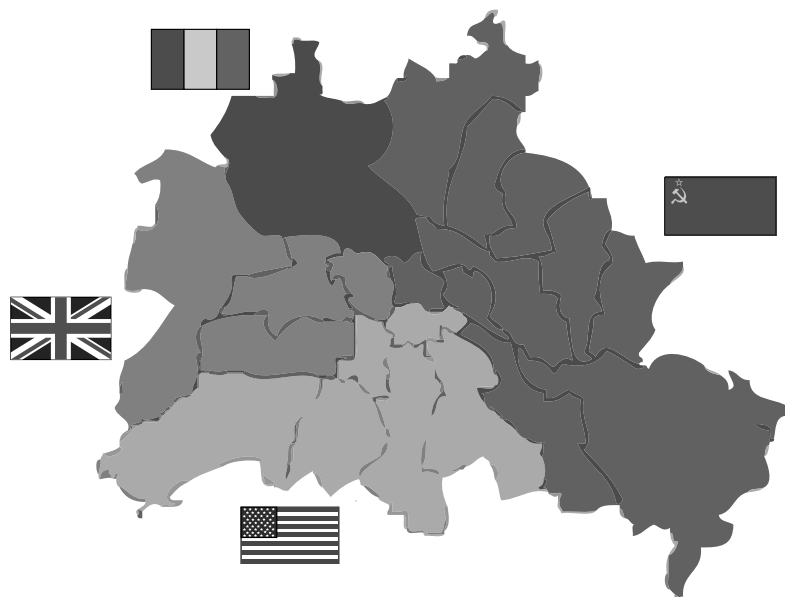

GO ON TO THE NEXT PAGE

Social Studies

4. Why was the Berlin Airlift necessary?
- A. The Yalta Conference had impoverished the citizens of Berlin.
 - B. The Marshall Plan had successfully assisted the citizens of Berlin to recover economically.
 - C. The creation of the Warsaw Pact had prevented Berliners from accessing food supplies.
 - D. The Soviets had closed supply routes to Berlin.
5. What event was a response to the formation of the North Atlantic Treaty Organization (NATO)?
- A. Communist countries united under the Warsaw Pact.
 - B. Allies implemented the Berlin Airlift.
 - C. Joseph Stalin blocked supplies to Berlin.
 - D. Germany was divided into four occupation zones.
6. Based on the map, which of the following statements is true?
- A. The United States controlled a larger part of Germany than any other nation.
 - B. The United States controlled the southwestern portion of Germany.
 - C. Great Britain controlled much of eastern Germany.
 - D. Joseph Stalin controlled only a small portion of Germany.

“Ulysses S. Grant concluded by 1863 that the very nature of a war to preserve the Union states would have the effect of changing those states and thus altering the Union.”

7. Which of the following historical developments best supports Grant’s conclusion?
- A. Grant had predicted a Northern triumph.
 - B. In 1917, the United States entered the First World War.
 - C. Women received the right to vote in 1919.
 - D. The emancipation of the slaves affected the society of the entire nation.
8. The Twenty-fourth Amendment states that “Non-payment of taxes cannot be used as a reason for denying to any citizen the right to vote for president, vice president, or a member of Congress.” This amendment to the U.S. Constitution upholds which of the following common law principles?
- A. No taxation without representation.
 - B. All citizens have the right to bear arms.
 - C. A person is innocent until proven guilty.
 - D. One person, one vote.

GO ON TO THE NEXT PAGE

Social Studies

Questions 9 and 10 are based on the following information.

Most of them were disappointed in their search for gold. Many of those who failed as prospectors settled in towns such as San Francisco and Monterey. There they found jobs working for the canneries that sprang up as a result of the booming fishing industry or digging in the gold mines that others had found.

9. Which of the following best explains why the men described in the passage traveled west?
- A. to live near the ocean
 - B. to start families
 - C. for economic and other opportunities
 - D. to escape religious persecution
10. According to the information, which of the following is a conclusion that best explains why many of those who headed west settled in coastal towns?
- A. They were able to find jobs there.
 - B. There was no available land.
 - C. Monterey rivers were rich in gold.
 - D. The mountains were not open to settlement.

Questions 11 and 12 refer to the following excerpt from the First Amendment to the U.S. Constitution.

“Congress shall make no law respecting an establishment of religion, or prohibiting the free exercise thereof; or abridging the freedom of speech, or of the press; or the right of the people peaceably to assemble, and to petition the Government...”

11. Which statement describes the primary purpose of the First Amendment?
- A. The First Amendment protects the right to bear arms.
 - B. The First Amendment increases the government’s restriction of individual freedoms, such as the freedom of religion, of speech, and of the press.
 - C. The First Amendment protects essential individual freedoms, such as the freedom of religion, of speech, and of the press.
 - D. The First Amendment prohibits Congress from making laws.
12. All of the following are guaranteed by the First Amendment EXCEPT
- A. the freedom to vote.
 - B. the freedom of petition.
 - C. the freedom of speech.
 - D. the freedom of the press.

GO ON TO THE NEXT PAGE

Social Studies

Question 13 is based on the following graph.

How Children Are Being Educated

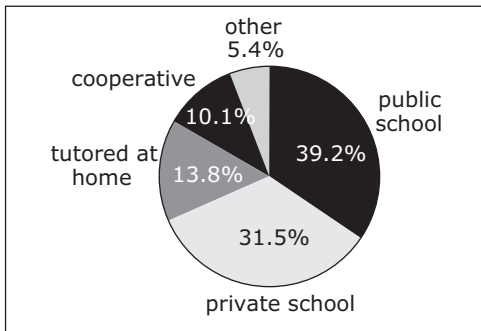

13. Which statement is supported by information in the graph?
- A. Private schools provide a better education than do other types of schooling.
 - B. Children prefer the educational arrangements their parents have made for them.
 - C. Tutoring at home is the most popular method of educating children.
 - D. Most children attend either public or private schools.

Questions 14 and 15 refer to the following information.

Economic systems can be classified according to the degree of government intervention and the type of control that the government exerts.

A command economy is one in which the government takes a very active role. If the government chooses to use its control of the economy to redistribute all of the money equally among all of the members of society, this is a command socialist system. If the government controls the economy but allows the money to be unevenly distributed, this is known as a command capitalistic system.

An economy in which the government takes no active role is known as a pure market economy. The only things that control the distribution of money in a pure market economy are market forces that no one person or organization can control.

14. It can be inferred from the passage that which of the following would NOT be found in a pure market economy?
- A. monopolies
 - B. small businesses
 - C. unemployed workers
 - D. taxes and welfare
15. Of the following groups, which would probably benefit the LEAST from a transition from a market economy to a socialist economy?
- A. government employees
 - B. the unemployed
 - C. small shop owners with small profits
 - D. highly skilled labor

GO ON TO THE NEXT PAGE

Social Studies

Question 16 refers to the following photo.



Source: Shutterstock

16. While today's car owners sometimes have difficulties, car owners in the early 20th century had to cope with quite a number of different problems.

Which of the following would have been the biggest concern for the people shown in the photo above?

- A. a lack of unleaded gas, which resulted in pollution
- B. a lack of seatbelts and other safety features
- C. a shortage of lightweight building materials, which led to much heavier cars than we have today
- D. a scarcity of gas stations

Question 17 refers to the following source.

"In the spring of 1879, thousands of colored people, unable longer to endure the intolerable hardships, injustice, and suffering inflicted upon them by a class of Democrats in the South, had, in utter despair, fled panic-stricken from their homes and sought protection among strangers in a strange land. Homeless, penniless, and in rags, these poor people were thronging the wharves of Saint Louis, crowding the steamers on the Mississippi River, and in pitiable destitution throwing themselves upon the charity of Kansas. Thousands more were congregating along the banks of the Mississippi River, hailing the passing steamers, and imploring them for a passage to the land of freedom, where the rights of citizens are respected and honest toil rewarded by honest compensation. The newspapers were filled with accounts of their destitution, and the very air was burdened with the cry of distress from a class of American citizens flying from persecutions which they could no longer endure."

Report and Testimony of the Select Committee of the United States Senate to Investigate the Cause of the Removal of the Negroes from the Southern States to the Northern States, 46th Congress, 1880.

17. According to the passage, why did many African Americans migrate to the North in 1879?
- A. to seek religious freedom
 - B. to find employment in factories
 - C. to escape poverty and racial discrimination
 - D. to escape lynchings

GO ON TO THE NEXT PAGE

Social Studies

Question 18 refers to the following graph.

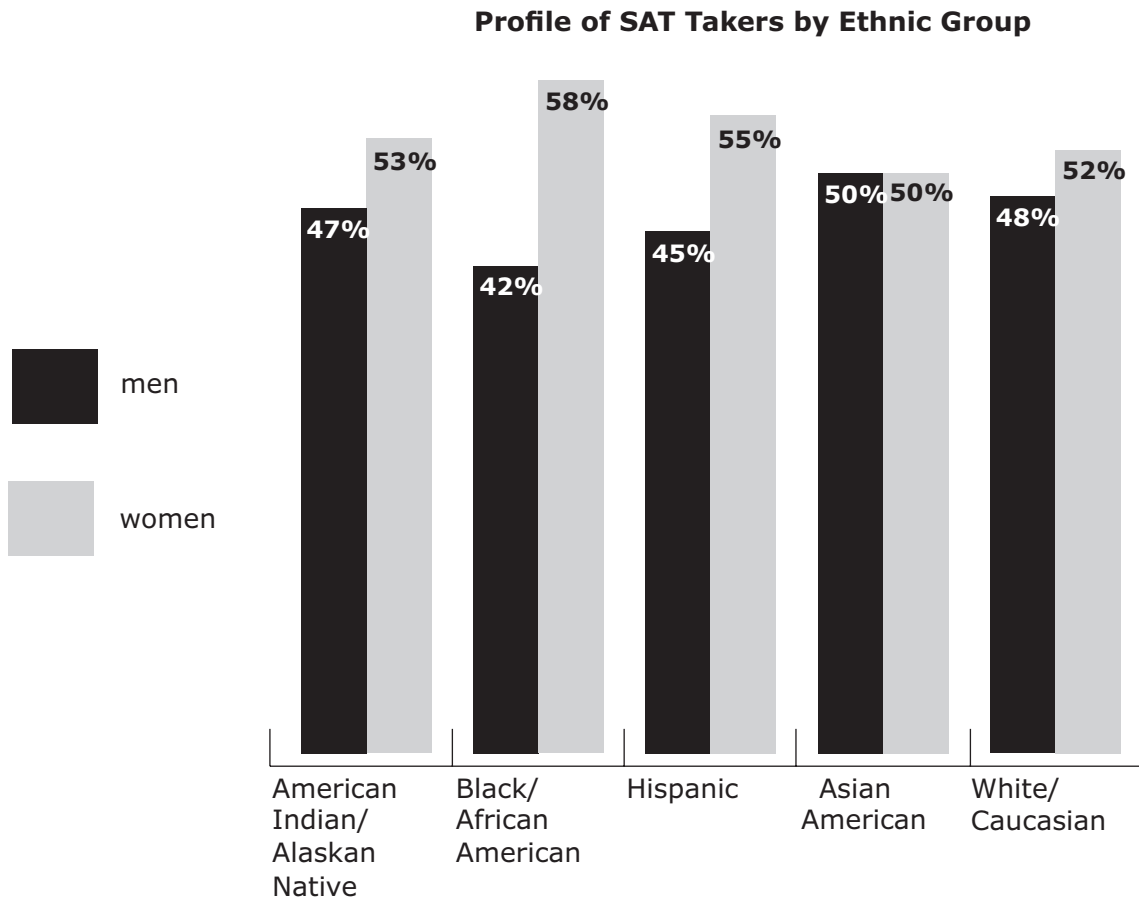

18. Which statement is clearly supported by evidence in the graph?
- A. American women perform better on the SAT than American men do.
 - B. There has been a decline in the number of Asian American men taking the SAT.
 - C. The number of women in general taking the SAT has increased.
 - D. More women than men take the SAT.

GO ON TO THE NEXT PAGE

Social Studies

19. A plutocracy may be defined by the political principle of rule by the wealthy, that is, those who have accumulated wealth either through inherited property or financial success.

According to this statement, which of the following is inconsistent with a plutocratic form of government?

- A. Citizens must abide by the decision of the select group in power.
- B. Monetary interests are valued above human interests.
- C. Leaders are determined by popular vote.
- D. A farmer is excluded from holding office.

Question 20 refers to the following quotation.

“The [oil monopoly] molds public opinion in a manner creating a complete misunderstanding of the petroleum situation and influences the judgment and acts of unknowing and unwise public officials to a point where they fall to these interests of monopoly as against the welfare of the people whom they are supposed to serve.”

—Andrew Mellon

20. Which of the following is an opinion most likely held by the speaker above?
- A. Those who profit from monopolies should not try to serve the public by running for office.
 - B. The interests of the people are secondary to those of public officials.
 - C. All should profit from the rewards gained by a monopoly.
 - D. Public officials should value the interests of the people they serve over the interests of any one business.

Question 21 refers to the following paragraph.

The U.S. government is structured with separate powers at the state and federal levels. Some political scientists have referred to this organization as a “wagon wheel,” with the hub, or center, representing the federal government and the spokes representing the various state governments. This means that each state is separate, but the federal government maintains some level of centralized power.

21. Which of the following best illustrates how the “wagon wheel” analogy applies to the U.S. system of government?
- A. A wagon wheel is one of four wheels needed to stabilize a wagon.
 - B. The hub of a wagon wheel holds in place the spokes, which strengthen the structure of the wheel.
 - C. A wagon wheel’s hub and spokes are made of different materials.
 - D. A wagon wheel is created in several pieces and then assembled.

GO ON TO THE NEXT PAGE

Social Studies

Questions 22 through 24 relate to the following map.

Non-English-Speaking Children*

*Children aged 5 to 17 who speak a foreign language at home and who don't speak English well or who don't speak it at all

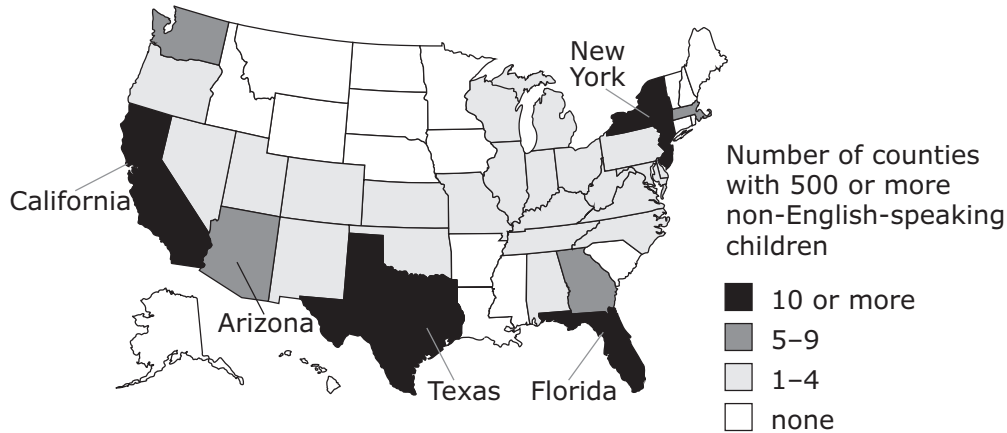

22. Which of the following best explains the distribution of non-English-speaking children shown on the map?
- A. Income taxes are lower on the coasts than in the middle of the country.
 - B. Fewer children are born in states with cold climates.
 - C. There are fewer English courses offered in the northern part of the United States.
 - D. Recent immigrants to the United States have tended to settle in border and coastal states.
23. Which factor would have the LEAST effect upon the distribution of non-English-speaking children in the United States?
- A. migration patterns
 - B. climate
 - C. ESL programs
 - D. immigration laws
24. Which generalization is supported by the evidence in the map?
- A. Non-English-speaking children are distributed evenly across the United States.
 - B. There are more non-English-speaking children in Arizona than in California.
 - C. In Texas and California, more children are unable to speak English than are able to speak English.
 - D. There are fewer non-English-speaking children in the northern middle portion of the United States than in other parts of the country.

GO ON TO THE NEXT PAGE

Social Studies

Questions 25 through 27 refer to the following paragraph.

The Constitution, the laws made in accordance with that Constitution, and any treaties that the United States has signed constitute the supreme law of the land, to which the judges in any state must adhere. Any state laws incompatible with this supreme law of the land are unconstitutional, and therefore null and void.

25. Which of the following is an example of the concept of supreme law?
- A. The president of the United States makes political appointments to the Supreme Court.
 - B. The freedoms outlined in the Bill of Rights can't be denied by the government.
 - C. The House of Representatives contains two representatives from each state.
 - D. The president is elected to four-year terms.
26. Which of the following is an example of a state law that would be incompatible with the Constitution?
- A. a law that prohibits protests by a steelworkers' union
 - B. a law that lowers the speed limit on a highway to 50 miles per hour
 - C. a law that limits state senators to two six-year terms each
 - D. legislation that requires reductions in emissions from factories
27. Which of the following is an example of a law compatible with the Constitution?
- A. legislation that prohibits the practice of certain religions
 - B. a law that protects the rights of convicted criminals
 - C. a law that suspends the right to trial by jury
 - D. a law that prevents non-English-speakers from voting

GO ON TO THE NEXT PAGE

Social Studies

Questions 28 and 29 are based on the following paragraphs.

According to several prominent professors of economics, it is impossible to be completely accurate when predicting the long-term performance of any given stock. The professors' arguments are that the various political, social, and economic pressures that affect the success of any company are constantly changing and that their combined effects are extremely unpredictable.

This would explain why an amateur investor can very often do as well as a professional stock trader in long-term investments. The professors likened predicting stock performance to predicting weather patterns. Weather predictions are usually accurate up to a few days into the future, but the farther ahead the prediction, the greater the likelihood that unforeseen events render the prediction inaccurate. The same may be true of long-term stock predictions.

28. After analyzing the success of long-term stock predictions, some business professors reported that
- A. professional predictions of stock performance are usually accurate.
 - B. stocks that are currently performing well will continue to do so.
 - C. amateur stock investors do very poorly in long-term investments.
 - D. even careful analysis of current stock performance is no guarantee of accurate long-term predictions.

29. If it is true that a company's performance is affected by many factors, one can conclude that

- A. two companies producing the same goods will perform equally well.
- B. a company's success is dependent on amateur investors.
- C. it is possible to lose money by investing in a company that has been very successful.
- D. an amateur stock investor will automatically make more money than a professional.

30. **Laissez-faire** is an economic environment in which transactions between private parties are largely free from government restrictions.

Choose THREE characteristics that best exemplify laissez-faire economics:

(a) Deregulation

(b) Labor Laws

(c) Building Codes

(d) Free Trade

(e) Antitrust Laws

(f) Non-Interference

Drag and drop your choices into the three slots above. (For this practice test, write the letters of three characteristics in the slots.)

GO ON TO THE NEXT PAGE

Social Studies

Question 31 refers to the photo below.



Source: Photofest Archives

31. The golden age of transatlantic passenger ships was quickly coming to an end in this photo taken of six ocean liners at dock in New York City circa 1953. Which of the following events was probably the most important reason for the end of the era of crossing the Atlantic by ship?
- A. A series of highly publicized liner accidents made the public too nervous to take ships.
 - B. A major war made overseas travel impossible.
 - C. The advent of passenger airlines cut down the time it took to get to Europe, leaving ships outmoded.
 - D. The cost of travel by boat became prohibitively expensive.

Question 32 refers to the following cartoon.

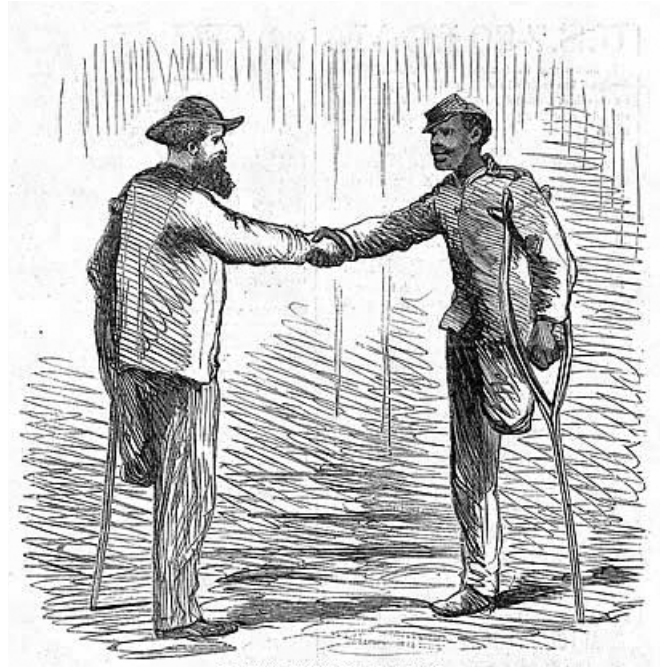

A MAN KNOWS A MAN

"Give me your hand, Comrade! We have each lost a LEG for the good cause; but, thank God, we never lost HEART."

32. This cartoon from the Civil War era depicts two veterans of the Civil War (which was fought over the emancipation of African American slaves) greeting each other. What did the cartoonist mean to imply by the caption?
- A. These two men were equals in each other's eyes.
 - B. These two soldiers who had lost their legs were not to be pitied because they were still men.
 - C. These soldiers had previously met.
 - D. Although they may have met before, these veterans had nothing in common.

GO ON TO THE NEXT PAGE

Social Studies

Questions 33 through 35 refer to the following sources.

TAB 1:

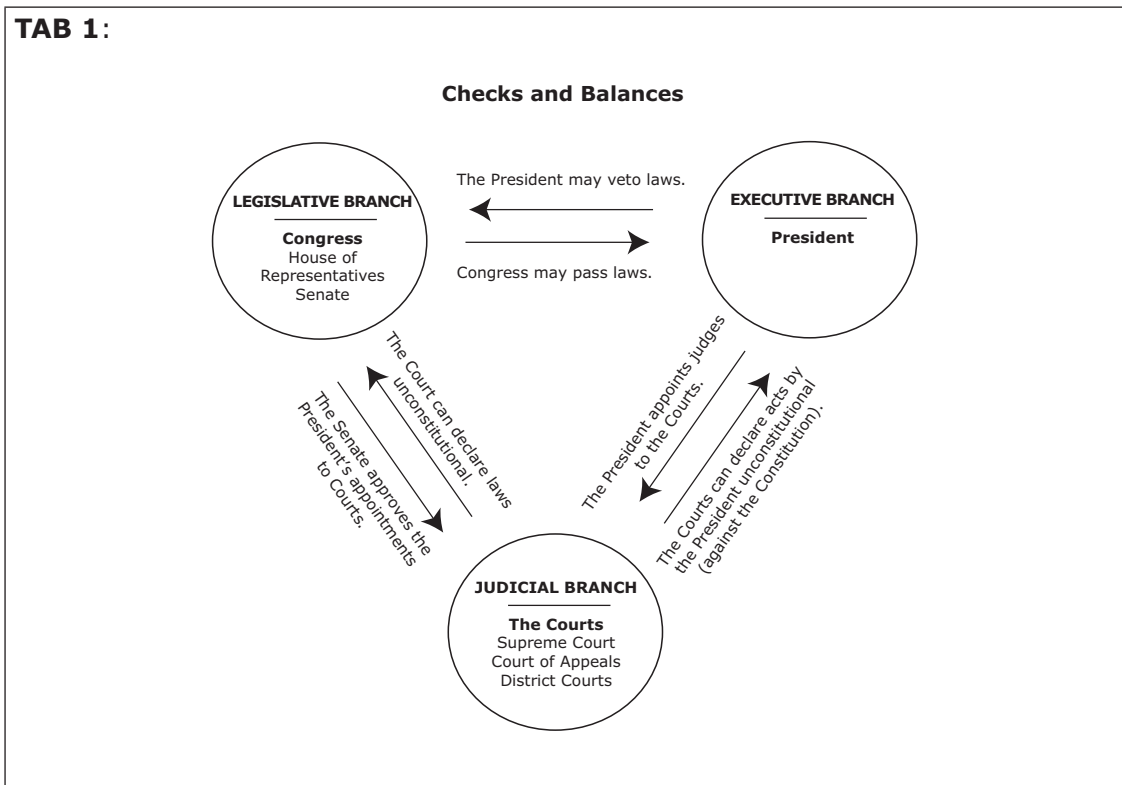

TAB 2:

"It is emphatically the province and duty of the Judicial Department [the judicial branch] to say what the law is. Those who apply the rule to particular cases must, of necessity, expound and interpret that rule. If two laws conflict with each other, the Courts must decide on the operation of each."

–Justice John Marshall, *Marbury vs. Madison*, 1803

TAB 3:

"You seem to consider the judges as the ultimate arbiters of all constitutional questions; a very dangerous doctrine indeed, and one which would place us under the despotism of an oligarchy. Our judges are as honest as other men, and not more so. They have, with others, the same passions for party, for power, and the privilege of their corps.... Their power [is] the more dangerous as they are in office for life, and not responsible, as the other functionaries are, to the elective control."

–Thomas Jefferson, in response to *Marbury vs. Madison*

GO ON TO THE NEXT PAGE

Social Studies

33. What is a primary duty of the Legislative Branch?
- A. to veto laws
 - B. to pass laws
 - C. to implement *Marbury vs. Madison*
 - D. to nominate and appoint judges to the Supreme Court
34. What was Thomas Jefferson's opinion of *Marbury vs. Madison*?
- A. It balanced federal power by giving federal judges the right to override unjust laws.
 - B. It conferred too much power to the Executive Branch.
 - C. It made judges as honest as other men.
 - D. It gave too much power to the Judicial Branch.
35. In context, what is the best substitute for the word "oligarchy"? (TAB 3)
- A. tyranny
 - B. democracy
 - C. passion
 - D. honesty

GO ON TO THE NEXT PAGE

Science

Welcome!

Here is some information that you need to know before you start this test:

- You should not spend too much time on a question if you are not certain of the answer; answer it the best you can, and go on to the next question.
- If you are not certain of the answer to a question, you can mark your answer for review and come back to it later.
- You have **90 minutes** to complete this test.

Turn the page to begin.

Science

Question 1 refers to the following photograph and chart.

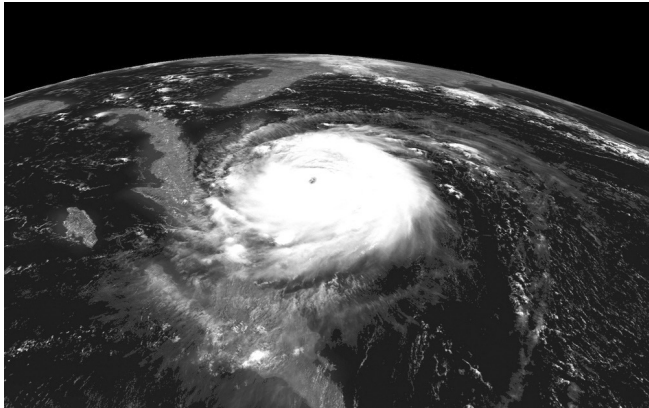

Source: Shutterstock

Average Temperature of Various Large Bodies of Water	
Atlantic Ocean	46 degrees Fahrenheit
Arctic Ocean	36 degrees Fahrenheit
Baltic Sea	45 degrees Fahrenheit
Great Lakes of North America	44 degrees Fahrenheit
Gulf of Mexico	60 degrees Fahrenheit

1. Hurricanes such as the one pictured above gather strength as they pass over warm water. According to the chart above, over which of the following bodies of water would a hurricane gather the most strength?
- A. Baltic Sea
 - B. Atlantic Ocean
 - C. Arctic Ocean
 - D. Gulf of Mexico

2. Blood is made up of two main elements: (1) plasma, which is largely water and proteins, and (2) the solid components of blood—red blood cells, white cells, and platelets (important for forming clots). If a patient has lost a lot of blood, he or she may receive a transfusion of “whole blood,” which includes red blood cells and plasma. However, sometimes the patient needs only an increase in the *volume* of liquid in the bloodstream, in which case plasma alone may be substituted.

A person must be tested for blood type before receiving certain kinds of transfusions because of differences in the ways that red blood cells react to one another. Under what conditions would such testing be necessary?

- A. for whole blood transfusions only
- B. for plasma transfusions only
- C. for both whole blood transfusions and plasma transfusions
- D. if the patient has not lost any blood

GO ON TO THE NEXT PAGE

Science

Questions 3 through 5 are based on the following information.

Coal is formed from the material of plants and other organisms that lived on land and whose remains were covered by mud, which later became rock. Coal is classified by carbon content.

Types of Coal

- Peat = The remains of plants and organisms that, because they were covered in bogs, were prevented by a lack of oxygen from completely decaying. Still a porous, soft brown mass, peat has a carbon content of 52%–60%.
- Lignite = In time, peat turns into lignite, a soft coal-like substance that is 60%–65% carbon.
- Subbituminous coal = With more time, heat, and pressure, lignite changes into subbituminous coal, which is about 65%–75% carbon.
- Bituminous coal = After even more heat and pressure, subbituminous coal turns into bituminous coal with a carbon level of 75%–85%.
- Anthracite = This is bituminous coal subjected to another million years of heat and pressure. Anthracite has a carbon level of 85%–95% and will burn only at extremely high temperatures.

3. A researcher analyzes a piece of coal and finds that it is unusually dense and burns only when subjected to very intense heat. What is the lowest percentage of carbon that this coal is likely to contain?

4. Steel is made in a process in which iron is combined with carbon at extremely high temperatures. Which of the following types of coal might be most useful in this process?

- A. peat
- B. lignite
- C. subbituminous coal
- D. anthracite

5. Drag and drop the appropriate type of coal into each box. (For this practice test, write the appropriate letter in each box.)

The type of coal most likely found closest to the surface of the earth:

The type of coal that contains the greatest amount of carbon per kilogram:

(a) Peat

(c) Bituminous coal

(b) Lignite

(d) Anthracite

GO ON TO THE NEXT PAGE

Science

Questions 6 and 7 are based on the following information.

Most seeds will germinate when they have moisture, oxygen, and the right temperature, but different seeds need differing proportions of each of these ingredients. Most seeds require a temperature of between 15 degrees and 27 degrees centigrade to germinate, although some seeds, such as the maple, can germinate in far colder climates, and some other seeds, such as corn, require warmer temperatures. Before germination, seeds must absorb water, but too much absorption of water will encourage the growth of fungus, which can halt the germination process.

6. Which of the following environments would be most suitable for the germination of corn seeds?
- A. a moist, sealed container at 26 degrees centigrade
 - B. an arid desert plain
 - C. a moist, plowed field at 30 degrees centigrade
 - D. an environment suitable for maple seed growth
7. Based on the information in the passage, which of the following is most likely true?
- A. Maple seeds can germinate in any temperature.
 - B. Corn is difficult to grow.
 - C. Water, in limited amounts, is vital to the germination process.
 - D. Maple seeds and corn seeds require different amounts of oxygen for germination.

8. During periods of intense activity, the cells of the body need more oxygen than the body is supplying, a situation known as oxygen debt. During these periods, the body's cells briefly switch to "anaerobic respiration," which produces lactic acid. The buildup of lactic acid in the tissues signals the brain to increase breathing and heart rates, thus supplying the body with more oxygen.

After which of the following activities would lactic acid most likely be found in the body?

- A. walking to work
 - B. playing an intense game of chess
 - C. taking an aerobics class
 - D. watching a scary movie
9. During periods that are unfavorable for growth, some plants become dormant. Woody plants are protected during such periods by their bark. Perennial plants die above ground, but their roots remain alive. Annual plants die, but their seeds survive to continue the life of the species.

Which of the following would most likely be a time of year during which plants might lie dormant?

- A. winter
- B. spring
- C. summer
- D. fall

GO ON TO THE NEXT PAGE

Science

Question 10 refers to the following diagram.

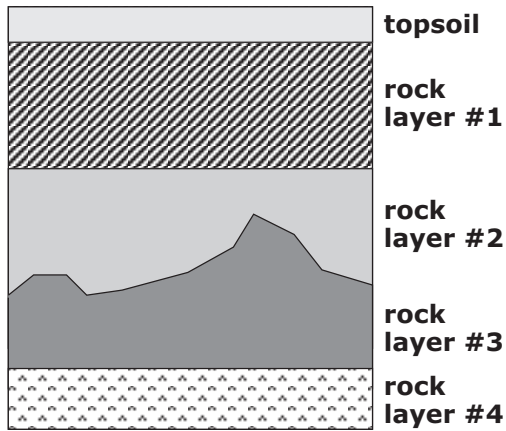

10. The diagram above shows various layers of rock that have been deposited over time. Drag and drop the rock layers into the appropriate boxes. (For this practice test, write the letters in the boxes.)

The oldest rock layer:	The newest rock layer:

(a) rock layer #1

(c) rock layer #3

(b) rock layer #2

(d) rock layer #4

Question 11 refers to the following diagram.

Food Chain

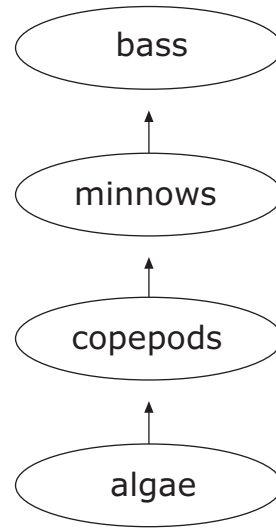

11. Which of the following conclusions is most likely to be true regarding the food chain above?
- A. Bass are the only fish that eat minnows.
 - B. Minnows are bigger than bass.
 - C. Bass benefit in some ways from the existence of copepods.
 - D. Bass could simply eliminate the middlemen by eating algae.

GO ON TO THE NEXT PAGE

Science

Question 12 is based on the following passage.

Passive protection is a method by which organisms protect themselves from predators, not by fighting, but by their appearance, smell, or sound. Protective resemblance is a type of passive protection in which an animal's coloring mimics the natural environment, acting as a kind of camouflage. Protective mimicry is another type of passive protection in which a defenseless organism resembles a more powerful organism. Another interesting example of passive protection is the Monarch butterfly, which smells and tastes so bad to other organisms that virtually no other animal or insect will eat it.

12. Which of the following is NOT an example of passive protection?
- A. A chameleon changes its color to blend in with a leaf in order to avoid predators.
 - B. The nonpoisonous scarlet kingsnake develops coloration very similar to that of the poisonous eastern coral snake.
 - C. An orchid flower mimics a female insect in order to lure male insects to it so the flower can be pollinated.
 - D. An edible vine adapts its leaves to match the inedible plant that it is climbing.
13. The density of seawater is 1,029 kilograms/meter³. 1 kilogram/liter = 1,000 kilograms/meter³. What is the density of seawater in kilograms/liter?

You may use a calculator.

- A. 0.0001029
- B. 0.1029
- C. 1.029
- D. 1,029,000

Question 14 refers to the following scenario.

Researchers in a particular city theorize that decreasing the greenhouse gas emissions in that city will result in better respiratory health for its citizens. In order to test this theory, they institute two programs. The first program provides commuters with financial incentives to take public transportation, and the second program initiates a respiratory care education campaign and provides free clinics for citizens suffering from respiratory health issues.

During the five years after the researchers institute the two programs, greenhouse gas emissions in the city decrease by 50%, and a citywide survey reveals that cases of illness due to respiratory problems have decreased by 65%. Researchers therefore conclude that their theory was correct: Decreasing greenhouse gas emissions resulted in better respiratory health for local citizens.

14. Which of the following best shows why the researchers' conclusion is flawed?
- A. They failed to compare the city's air quality to that of any other towns, so they don't know if greenhouse gases decreased more or less than they should have.
 - B. They should have tested the city's drinking water, too, since that has a greater effect on citizens' health than air quality does.
 - C. Their conclusion doesn't explain the 15% difference between the decrease in greenhouse gases and the decrease in respiratory problems.
 - D. They instituted two programs instead of one, so they can't be sure which is responsible for the resulting health improvements.

GO ON TO THE NEXT PAGE

Science

15. Lobsters are crustaceans commonly found in the waters of the Atlantic Ocean off the North American coast between Maine and North Carolina. Researchers studied the weights of these creatures over a period of a few years. Some of the results are displayed in the table below.

Year	Average Weight (kg)
2005	0.43
2006	0.41
2007	0.37
2008	0.43
2009	0.38

The researchers hope to find the most commonly occurring lobster weight for the lobsters studied during the five-year period shown above. The researchers

must calculate the ▼

average
mode
median
range

of the weights, which is ▼.

0.04 kg
0.40 kg
0.41 kg
0.43 kg

You may use a calculator.

16. Amy tracks the monthly snowfall in two areas over a period of several months. One area is a region of high elevation, and the other is an area of low elevation. The table below displays her results.

Month	Area	Meters
November	low elevation	0.2
November	high elevation	0.4
December	low elevation	0.2
December	high elevation	0.8
January	low elevation	0.9
January	high elevation	1.7
February	low elevation	1.3
February	high elevation	1.8
March	low elevation	0.9
March	high elevation	1.1

What is the mean of the data shown in the table?

You may use a calculator.

meters

GO ON TO THE NEXT PAGE

Science

17. Scientists calculate the pressure within a gas by using the following equation:

$$P = \frac{N \times k \times T}{V}$$

In the equation:

P is the pressure of the gas;
 N is the number of particles in the gas;
 k is a constant;
 T is the temperature of the gas;
 V is the volume of the gas.

If the number of particles in the gas decreases, which of the following changes will increase in the pressure of the gas?

- A. decreasing both the volume and the temperature of the gas
- B. increasing both the volume and the temperature of the gas
- C. increasing the volume and decreasing the temperature of the gas
- D. decreasing the volume and increasing the temperature of the gas

18. There are four basic types of chemical reactions, as shown in the table below.

Reaction Type	General Example
Combination	$A + B \rightarrow C$
Decomposition	$C \rightarrow A + B$
Single displacement	$A + BC \rightarrow B + AC$
Double displacement	$AB + CD \rightarrow AC + BD$

The balanced chemical equation describing the reaction between hydrogen and fluorine is shown below.

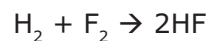

Which of the four basic types of chemical reactions is this?

- A. combination
- B. decomposition
- C. single displacement
- D. double displacement

GO ON TO THE NEXT PAGE

Science

Question 19 refers to the following graph.

Projected AIDS Deaths 2011–2020

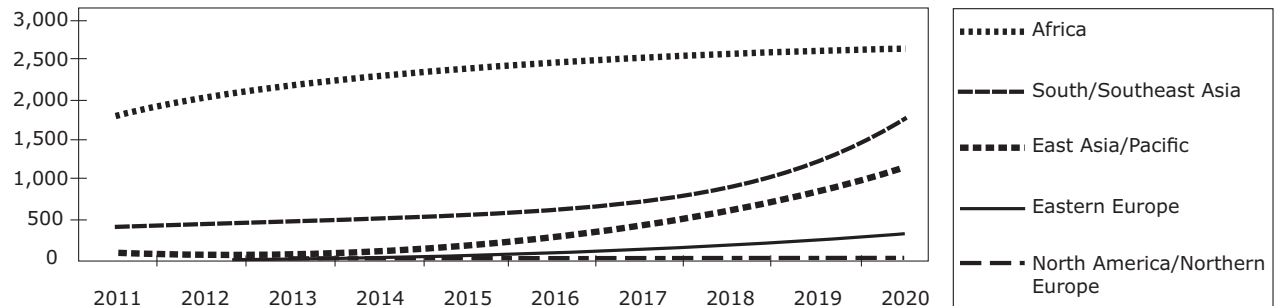

Source: World Health Organization

19. According to the chart above, which of the following regions will have the largest projected increase in the number of AIDS deaths between 2011 and 2020?

- A. Africa
- B. South/Southeast Asia
- C. Eastern Europe
- D. North America/Northern Europe

GO ON TO THE NEXT PAGE

Science

20. Scientists classify stars according to the following categories: O, B, A, F, G, K, M. A star's category depends upon its *spectral type*, which is determined by its temperature. The chart below shows five stars of different categories, along with their temperatures.

Star Type	Temperature (°F)
O	18,033
B	9,978
A	4,839
F	3,644
G	3,422

However, rather than measuring star temperature in degrees Fahrenheit, scientists typically measure star temperature in units of Kelvin. The conversion from Kelvin to Fahrenheit is given by the following formula:

$$K = \frac{5}{9} (^{\circ}\text{F} - 32) + 273.$$

What is the approximate temperature of the A-type star in Kelvin?

You may use a calculator.

- A. 2,569
- B. 2,822
- C. 2,929
- D. 2,944

Questions 21 and 22 refer to the following graph.

Waves That Foretell Tidal Waves

Seismometer readings of Earth motion from the Fault City quake reflect much larger long-period surface waves at point R1 than those from the Nicaragua quake.

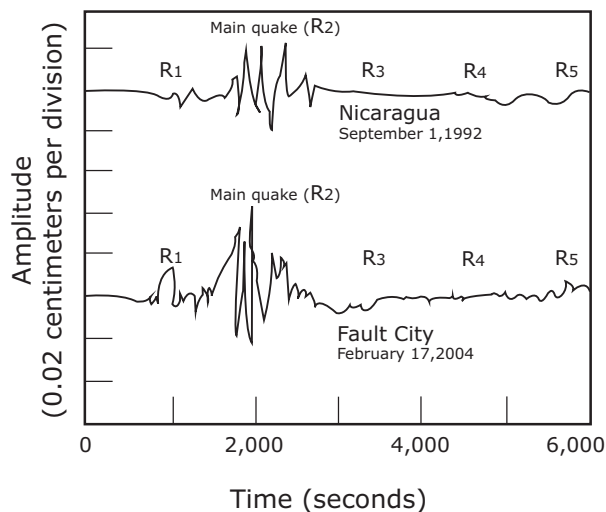

21. According to the information above, which of the following statements is true?
- A. The Nicaragua main quake had a larger amplitude than did the Fault City quake.
 - B. The Fault City main quake had a larger amplitude than did the Nicaragua quake.
 - C. A seismometer was used to measure the Nicaragua quake but was not used to measure the Fault City quake.
 - D. The long-period surface waves at the point R1 were larger during the Nicaragua quake than during the Fault City quake.
22. Select the point on the graph that would be of the most importance in foretelling an earthquake in Nicaragua. (For this practice test, write an X on the graph.)

GO ON TO THE NEXT PAGE

Science

Questions 23 and 24 refer to the following article.

23. For years, paleontologists have debated whether the archaeopteryx, a creature that lived 150 million years ago, was an early species of bird or a dinosaur that spent most of its time on the ground. Its feathers and wings were of only limited use, they say, and could not sustain flight.

Ornithologists, on the other hand, believe that archaeopteryx was first and foremost a bird. As evidence, they point to fossil remains of the creature that show its claws were curved so that it could perch on tree limbs. Curved claws would have prevented the animal from walking or running quickly on the ground.

According to paleontologists, the archaeopteryx was incapable of

- A. perching.
 - B. running.
 - C. flying.
 - D. walking.
24. According to the theory advanced by ornithologists, which of the following is most likely to have been a modern-day descendant of the archaeopteryx?
- A. the lizard
 - B. the alligator
 - C. the crow
 - D. the mosquito

25. In science, work is defined as the component of force parallel to motion multiplied by displacement. One reason that individuals use ramps, rather than lifting heavy items straight up, is that using a ramp increases total displacement, but reduces the amount of force required to move an object by exactly the same amount as the increase in displacement, provided that the ramp's surface is frictionless.

According to the information in the paragraph, using a ramp with a frictionless surface will have which of the following effects?

- A. The total amount of work required to move an object will decrease.
- B. The total amount of work required to move an object will increase.
- C. The total amount of work required to move an object will remain the same.
- D. The amount of work required to move an object will initially increase, but will later decrease.

26. Below is a table listing the concentrations of chemicals found in human blood and urine.

	Albumin mg/dL	Chloride mg/dL	Glucose mg/dL	Phosphate mg/dL	Urea mg/dL
Blood	4.1	92	95	2.5	4.5
Urine	—	53	—	0.15	1.6

Based on the table above, which of the following chemicals is NOT normally found in urine?

- A. albumin only
- B. chloride only
- C. glucose only
- D. albumin and glucose

GO ON TO THE NEXT PAGE

Science

27. In a certain forest, foxes prey on rabbits. A virus that infects only rabbits spreads through the forest, killing many rabbits.

Which of the following is most likely to occur to the fox population?

- A. It will decrease, because the foxes will not have enough food.
- B. It will decrease, because the foxes will suffer from the virus.
- C. It will increase, because the foxes will no longer need to compete with the rabbits for food.
- D. It will increase, because the foxes will evolve to become more resistant to disease.

28. A solar eclipse is a celestial event during which the sun appears partially or totally obstructed when viewed from a certain location on Earth. The diagram below shows a solar eclipse.

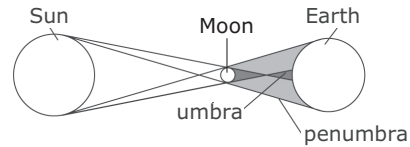

Based on the information above, which of the following is mostly likely to be true during a solar eclipse?

- A. The entire moon is in the penumbra, or shadow, of the earth, so that the moon is no longer visible from the earth.
- B. The moon is directly between the sun and the earth, thus placing certain regions of the earth within the moon's umbra, or deepest part of the shadow, so that the sun's rays are not visible from those regions.
- C. Light rays from the earth intercept those from the sun, thus creating an umbra, or dark shadow, around the moon so that the sun is no longer visible from the earth.
- D. The sun is in the umbra, or deepest part of the shadow, cast by the earth, and is therefore invisible from the earth.

GO ON TO THE NEXT PAGE

Science

Questions 29 and 30 refer to the following passage.

Pathogenic microbes, microorganisms that cause disease, include viruses, bacteria, fungi, and protozoa. Such microbes can invade hosts through several pathways, including through the air, through direct or indirect physical contact, through blood, and through other bodily fluids.

Medical researchers are currently attempting to find better treatments for microbial diseases by developing new pharmaceuticals. Currently, many doctors prescribe penicillin, which is derived from the spores of a fungus and which prevents the growth of new bacteria, to treat bacteria-induced microbial diseases, and antiviral compounds to combat viruses. However, such treatments do not always eradicate the relevant diseases, and while some microbe-induced illnesses, such as chicken pox, may not be life-threatening, others, such as those that cause ebola, can be deadly.

29. Below is a chart of some common microbe-induced illnesses and their causes.

Illness	Cause
Common Cold	Rhinovirus
Strep Throat	Streptococcal bacterium
Athlete's Foot	Candida yeast
Malaria	Malaria protist

Which of the following is most likely treatable with penicillin?

- A. common cold
- B. strep throat
- C. athlete's foot
- D. malaria

30. Medical researchers fear that preventing those suffering from microbial diseases from having physical contact with others may not be sufficient to stop the spread of such diseases. Which of the following quotes from the passage supports this idea?
- A. "Many doctors prescribe penicillin, which is derived from the spores of a fungus and which prevents the growth of new bacteria, to treat bacteria-induced microbial diseases."
 - B. "Such treatments do not always eradicate the relevant diseases, and while some microbe-induced illnesses, such as chicken pox, may not be life-threatening, others, such as those that cause ebola, can be deadly."
 - C. "Pathogenic microbes, microorganisms that cause disease, include viruses, bacteria, fungi, and protozoa."
 - D. "Such microbes can invade hosts through several pathways, including through the air, through direct or indirect physical contact, through blood, and through other bodily fluids."

GO ON TO THE NEXT PAGE

Questions 31 and 32 refer to the following passage.

Hereditary traits are encoded by genes that are located on chromosomes. Chromosomes come in pairs, and the pair of genes for a particular feature determines the characteristics of that trait. In many cases, genes exhibit a pattern called classical dominance. In such cases, the gene for a dominant trait is always expressed when present. An individual may have only a dominant gene and have two copies of that gene, or an individual may be hybrid and have one dominant gene and one recessive gene. In hybrids, the dominant gene hides the expression of the recessive gene. A recessive gene is expressed only when both copies of the gene are recessive. In literature, dominant genes are represented by capital letters, while recessive genes are represented by lowercase letters.

In pea plants, pea color is a hereditary trait. Green comes from a dominant gene, and yellow comes from a recessive gene, so that if a plant has one gene for green and one gene for yellow, that plant will produce green peas.

The following Punnett Square shows the results when two hybrid pea plants produce new plants. Punnett Squares predict the likelihood of a specific gene combination occurring. Approximately 75% of the offspring in this case are green, and the rest are yellow.

Punnett Square—Color in Pea Plants

	●	●
♫	GG	Gg
♫	Gg	gg

♫	sperm cell of male parent
●	egg cell of female parent
G	dominant green color gene
g	recessive yellow color gene

31. Which of the following is the best explanation for the results displayed in this Punnett Square?
- A. One parent plant had only the yellow gene.
 - B. One parent plant had only the dominant gene.
 - C. Neither parent plant had the hidden gene for yellow.
 - D. Both parent plants were hybrids and carried the hidden gene for yellow.
32. Dimples result from a dominant gene, and a lack of dimples results from a recessive gene. Based on the information in the passage, which of the following will be true for an individual who is a hybrid?
- A. That individual will have dimples.
 - B. That individual has an equal chance of either having or not having dimples.
 - C. That individual will have a dimple on one side of his or her face, but not on the other.
 - D. That individual will have no dimples.

GO ON TO THE NEXT PAGE

Science

Questions 33 and 34 refer to the following graph.

The graph below shows a science experiment in which a sample of ice at -20 degrees C is heated to 120 degrees C. During the experiment, the ice melted into water and then the water boiled and turned into steam.

Heat and Temperature of Water

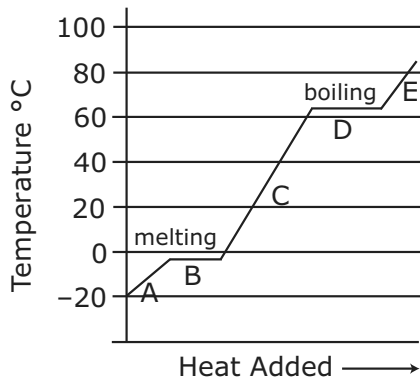

33. Based on the information presented above, which of the following statements is most accurate?

- A. The temperature of the sample increased at the same rate throughout the experiment.
- B. The sample remained as ice throughout most of the experiment.
- C. The sample increased in temperature, then melted, then increased in temperature again, then boiled, and then increased in temperature.
- D. The sample melted and increased in temperature at the same time.

34. Select the area on the graph during which the entire sample consists of liquid water. (For this practice test, write an X on the graph.)

35. Bees are insects that play an important role in any ecosystem that has flowering plants. Bees serve as primary pollinators, and enable flowering plants to reproduce. Scientists estimate that nearly one-third of the human food supply consists of plants that depend on bees for pollination.

Based on the information above, which characteristic of bees is most important to an ecosystem?

- A. Bees create honey for human consumption.
- B. Bees serve as pollinators.
- C. Bees sting harmful insects that would otherwise eat and destroy plants.
- D. Bees transfer their genes to plants.

END OF TEST